



Technical Data Sheet

Installation & Commissioning Manual MX4100, MX4200 & MX4400 Fire Alarm Control Panels



The operation and functions described in the manual are available from Software Versions Mx4100-015, Mx4200-015 and Mx4400-015 onwards.

Specifications

	<i>Mx-4100</i>	<i>Mx-4200</i>	<i>Mx-4400</i>
Enclosure	Steel IP40	Steel IP 40	Steel IP40
Dimensions H x W x D mm	320 x 345 x 85	475 x 450 x 115	475 x 450 x 115
Weight	5Kg	10.5Kg	10.5Kg
Temperature	0°C to 45°C	0°to 45°C	0°C to 45°C
Cable Entries (20mm knockouts)	7 x top and 7 x top rear	18 x top, 9 x top rear and 2 x bottom	18 x top, 9 x top rear and 2 x bottom
Mains Supply	230V 50/60Hz AC (+10%, -15%) 0.4A max	90 –265V, 47 –63 Hz AC, 1.9A @ 90V, 0.64A @ 265V	90 - 265V, 47-63Hz AC, 2.3A @ 90V, 0.95A @ 265V
Battery Capacity (For 24Hr. standby)	24V 4Ah Internal (min) 24V 7Ah Internal (max) 24V 12Ah External max.	24V 4Ah Internal (minimum) 24V 17Ah Internal (maximum) 24V 48 Ah External (max)	24V 4Ah Internal (minimum) 24V 17 Ah Internal (maximum) 24V 48Ah External (max)
Charging Current	0.4A Temperature Compensated	2A Temperature Compensated	2.2A Temperature Compensated
Power Supply	On-board 24V DC, 2A High Efficiency Switched Mode	Separate 24V DC, 4A Universal Input Switched Mode	Separate 24V DC, 5A Universal Input Switched Mode
Number of Fire Zones	100 (250 when networked)	200 (1000 when networked)	200 (1000 when Networked)
Number of Loops	1	1 to 2	1 to 4
Devices per Loop	As per Detector Manufacturer's Specifications		
Loop Current	* 500mA max.	500mA max. per Loop	500mA max. per Loop
Protocols	Apollo: S90, XP95, Discovery, Explorer & Hochiki ESP		
Sounder Outputs	* 2 x 1A Programmable (Total output current from panel not to exceed 2Amps)	2 x 1A Programmable	4 x 1A Programmable
Relay Outputs	2 x 1A 30VAC/DC (max) 10mA 5V (min) Programmable	2 x 1A 30V AC/DC (max) 10mA. 5V (min) Programmable	2 x 1A 30V AC/DC (max) 10mA. 5V (min) Programmable
Open Collector Outputs	2 x Programmable 10mA 30V DC (max)	2 x Programmable 10mA 30V DC (max)	2 x Programmable 10mA 30V DC (max)
Digital Outputs	---	6 x Programmable	6 x Programmable
Auxiliary Supply Output	24V DC, 300mA See notes	24V DC, 300mA See notes	24V DC, 300mA See notes
Event Log	1000 Event & Diagnostic + 500 Fire		

Notes

Aux supply tracks a maximum of 0.5V below battery terminal voltage when no mains supply available.

Document Reference	680-014	Rev	06	Author	PS	RFM4100	Page	2 of 53
--------------------	---------	-----	----	--------	----	---------	------	---------

Standards:

The *Mx-4100*, *4200* and *Mx-4400* Fire Alarm Control Panels conform to the following standards:

BS EN54-2: 1998 Control and Indicating Equipment

BS EN54-4: 1998 Power Supply Equipment

BS EN60950: 2000 Safety of information technology equipment

BS EN50130-4: 196 Product Family Standard

Electromagnetic Compatibility Directive 89/336/EEC (and the amending directive 92/23/EEC)

Low Voltage Directive 73/23/EEC

Contents

1	Introduction	6
1.1	EN54 Functions	7
1.2	Installation Approvals	7
1.2.1	Fire System Installations	7
1.2.2	Wiring Regulations	7
2	Installation	8
2.1	Identification of Parts	8
2.1.1	Mx-4100	8
2.1.2	Mx-4200 & Mx-4400	8
2.2	Installing the Mx-4100 Enclosure	9
2.2.1	Removing and Replacing the Enclosure Cover of the Mx-4100	9
2.2.2	Removing the Chassis	9
2.2.3	Mounting the Enclosure	9
2.2.4	Remounting the Chassis	10
2.2.5	Recommended Cable Routing Arrangement	10
2.3	Installing the Mx-4200 & 4400 Enclosures	11
2.3.1	Opening the Enclosure Cover	11
2.3.2	Removing the Chassis	11
2.3.3	Mounting the Enclosure	11
2.3.4	Remounting the Chassis	12
2.3.5	Recommended Cable Routing Arrangement	12
2.3.6	Installing Additional Loop Circuits in the Mx4200 & Mx-4400	13
2.3.7	Removing a Loop Driver Card	13
2.4	Wiring Installation	14
2.4.1	AC Mains Wiring	14
2.4.1.1	Cable Gland	14
2.4.2	Battery Installation	15
2.4.2.1	Mx-4100	15
2.4.2.2	Mx-4200 & Mx-4400	16
2.4.3	Detector Loop Installation	17
2.4.4	Sounder Circuits	18
2.4.5	Relay Circuits	18
2.4.6	Open Collector Outputs	19
2.4.7	Auxiliary Supply Output	19
2.4.8	RS232 Interface	20

3	Programming	21
3.1	Introduction	21
3.1.1	Access Levels	21
3.1.2	Memory Lock	21
3.1.3	Navigating through menus	21
3.1.4	Changing Text Descriptions	22
3.1.5	Numeric data entry	23
3.2	Recommended Programming Procedure	23
3.3	Level 3 Menu Functions	23
3.3.1	Loops	24
3.3.2	Loops - View/Edit	24
3.3.2.1	State	24
3.3.2.2	Type	24
3.3.2.3	Value	25
3.3.2.4	Zone	25
3.3.2.5	Device Text	25
3.3.2.6	Action	25
3.3.2.7	Sensitivity	26
3.3.2.7.1	Mode- Apollo:	26
3.3.2.7.2	Mode- Hochiki:	26
3.3.2.7.3	Delay	27
3.3.2.7.4	Alarm- Apollo	27
3.3.2.7.5	Alarm- Hochiki	27
3.3.2.7.6	Pre-Alarm	27
3.3.2.7.7	Minimum Value	27
3.3.2.7.8	Special Sensitivity Mode SSM/Clock	27
3.3.2.8	O/P Group	28
3.3.2.9	Additional Info	28
3.3.2.10	Detector Testing	29
3.3.3	Loops - Auto Learn	29
3.3.3.1	Normal Procedure / Initial learn	29
3.3.3.2	Procedure if the Panel finds Devices Missing	30
3.3.3.3	Procedure if the Panel finds Devices Added	30
3.3.3.4	Procedure if the Panel finds Devices Changed	30
3.3.4	Zones	31
3.3.5	Exit	31
3.3.6	Outputs	32
3.3.6.1	Default Output Settings	32
3.3.6.2	Cause	33
3.3.6.3	Style	34
3.3.6.3.1	Delay	34
3.3.6.3.2	Mode	34
3.3.6.3.3	Wait	34
3.3.6.4	Copying Output Settings to Multiple Zones	34
3.3.7	Investigation Delays	35
3.3.7.1	Overriding Delays at Level 1	35
3.3.8	Time and Date	35
3.3.9	View Options	36
3.3.10	Passwords	36
3.3.11	Panel	36
3.3.12	PC Config	37
3.3.13	Setup	37
3.3.13.1	Network	37
3.3.13.2	Panel Zone	37
3.3.13.3	Service Number	37
3.3.13.4	Service Due Date	38
3.3.13.5	Trace Logging Mode	38
3.3.13.6	Detector Blinking	38
3.3.13.7	Company LCD Logo	39

3.3.13.8	Program ID	39
3.3.13.9	Config Data	39
4	EN54 Optional Features	40
5	Service and Maintenance	41
5.1	Maintenance Schedule	41
5.1.1	Daily Actions	41
5.1.2	Monthly Actions	41
5.1.3	Quarterly Actions	41
5.1.4	Annual Actions	41
5.2	Replacement of Components	42
5.2.1	Batteries	42
5.2.1.1	Standby Batteries	42
5.2.1.2	Lithium Battery	42
5.2.2	Liquid Crystal Display	43
6	Appendices	44
6.1	Appendix 1 – Forgotten Level 3 Password	44
6.2	Appendix 2 – Recommended Cables	45
6.3	Appendix 3 – Battery Standby Calculation Chart	46
6.3.1	Mx-4100	46
6.3.2	Mx-4400 & Mx-4200	47
6.4	Appendix 4 – Cause and Effect Programming Example	48
6.4.1	Introduction	48
6.4.2	Output Groups	48
6.4.3	Styles	48
6.4.4	Output Group Programming	49
6.5	Appendix 5 – Apollo Information	50
6.5.1	View Drift	50
6.5.2	Rapid Compensation	50
6.5.3	View EEPROM	51
6.6	Appendix 6 – Hochiki Esp Information	52
6.6.1	Unprocessed Analogue information	52
6.6.2	CHQ-BS Sounders	52
6.7	Appendix 7 – Mx4000 Series Loop Output Drive Capability	53
6.7.1	Hochiki	53
6.7.2	Apollo	53

Cautions and Warnings



BEFORE INSTALLATION – Refer To the Ratings shown on the label inside the product and to the ‘Specifications Chart’ in this document.

Please read this manual carefully. If you are unclear on any point, DO NOT proceed. Contact the manufacturer or supplier for clarification and guidance.



Only Trained service personnel should undertake the Installation, Programming and Maintenance of this equipment.



This product has been designed to comply with the requirements of the Low Voltage Safety and the EMC Directives. Failure to follow the installation instructions may compromise its adherence to these standards.



This equipment is constructed with static sensitive components. Observe anti-static precautions at all times when handling printed circuit boards. Wear an anti-static earth strap connected to panel enclosure earth point. Before installing or removing any printed circuit boards remove all sources of power (mains and battery).

1 Introduction

This manual covers the installation, programming and commissioning of the *Mx-4100*, *Mx-4200* and *Mx-4400* Fire Alarm Control Panels. Refer to the User Manual (Document No. 680-015) for details of how to operate the panel.

The *Mx-4100* is a Single Loop, Analogue Addressable Fire Alarm Control Panel.

The *Mx-4200* is a Multiple Loop, Analogue Addressable Fire Alarm Control Panel with provision for up to two loops.

The *Mx-4400* is a Multiple Loop, Analogue Addressable Fire Alarm Control Panel with provision for up to four loops.

All three panels are designed for use with the Apollo Discovery, Explorer , XP95 and Series 90 and Hochiki ESP fire detection devices.

Install the panel, detection loops, sounder circuits, etc. in accordance with the instructions in Section 2 and then program the operation in accordance with the instructions detailed in Section 3.

1.1 EN54 Functions

	<p>This Fire Alarm Control Panel is compliant with the requirements of EN54 parts 2 and 4 (1997).</p> <p>In addition to the basic requirements, the following optional functions are provided and these comply with the requirements of EN54.</p>
---	---

	C.I.E Optional Functions		EN54-2 Clause
	Indication	Fault Signals from Points	8.3
Outputs	Outputs to Fire Alarm Devices	7.8	
Controls	Investigation Delays to Outputs	7.11	
	Co-incident Detection	7.12	
	Disablement of Points	9.5	
	Test Condition	10	

	P.S.E Functions		EN54-4 Clause
	Operation from a main power supply		5.1
Operation from a standby battery		5.2	
Monitor and Charge the Standby Battery		5.3	
Recognise and Notify Supply Faults		5.4	

	This Fire Alarm Control Panel also supports additional functions that are not covered by EN54. These are as follows:	
	Additional Function	Refer to Paragraphs
Programmable Cause / Effect on Outputs (Phased Evacuation)	6.4	
Auxiliary Power Supply Output	2.4.7	
Auxiliary Relay Outputs	2.4.5	
Printer Option	User Manual	

1.2 Installation Approvals

1.2.1 Fire System Installations

The panel must be installed and configured for operation in accordance with these instructions and the applicable fire systems installation regulations appropriate to the country and location of the installation.

1.2.2 Wiring Regulations

The panel and system must be installed in accordance with these instructions and the applicable wiring codes and regulations appropriate to the country and location of the installation.

In the UK, the installation must comply with the requirements of the IEE Wiring Regulations – Sixteenth Edition or later.

Document Reference	680-014	Rev	06	Author	PS	RFM4100	Page	7 of 53
--------------------	---------	-----	----	--------	----	---------	------	---------

2 Installation

2.1 Identification of Parts

The following diagram shows the major parts of the panel.

2.1.1 Mx-4100

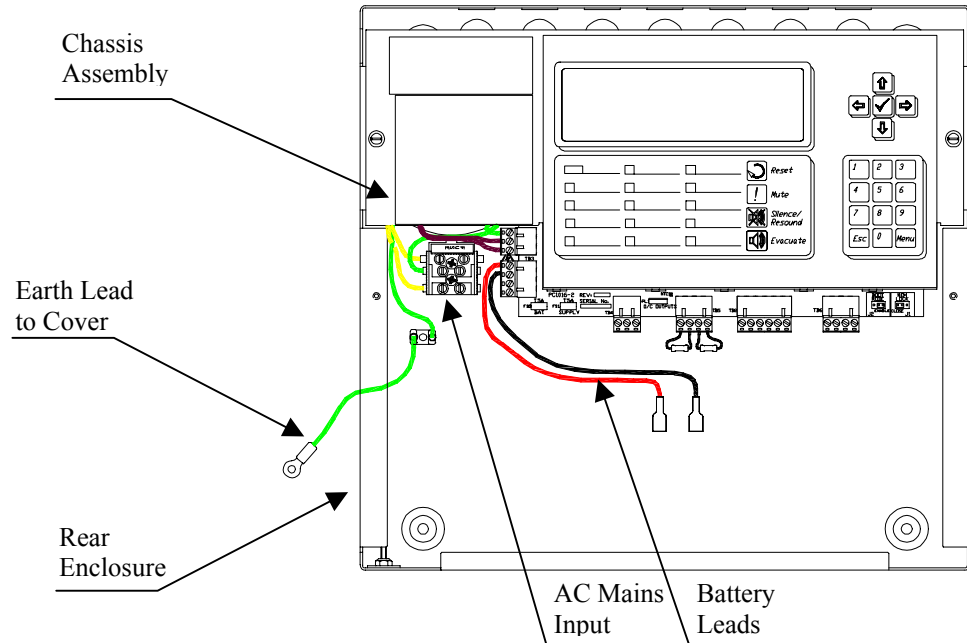

2.1.2 Mx-4200 & Mx-4400

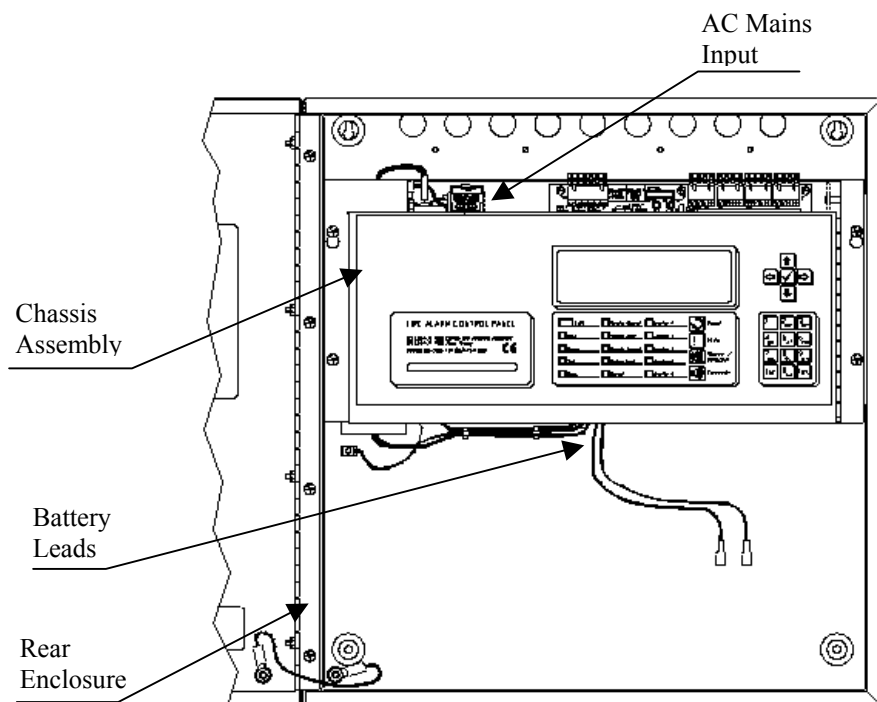

2.2 Installing the Mx-4100 Enclosure



The panel can weigh in excess of 15kg when the batteries are installed. Use appropriate fixing hardware to secure the panel to the wall. Observe recommended lifting practices to guard against spinal injury.

2.2.1 Removing and Replacing the Enclosure Cover of the Mx-4100

The enclosure cover is fixed in place with two tamper resistant hexagon key screws. These require the use of a 2.5mm Allen Key.

The enclosure cover must be connected to earth. When replacing the cover, always ensure that the earth lead spade terminal is securely seated onto the blade terminal in the backbox.

2.2.2 Removing the Chassis

It is recommended that the chassis be removed before fitting the panel to the wall. To remove the chassis:

Disconnect the earth cable connecting the chassis to the spade terminal on the rear enclosure.

Remove the two screws holding the chassis to the back box. Keep these items in a safe place for later re-use.

Unplug the 3-way connector feeding the power supply to the Base Card. Carefully remove the chassis from the rear enclosure and place in a safe place to prevent accidental damage.



Do not lift the chassis by holding onto any of the printed circuit cards. Hold the chassis by the metal plate only.

2.2.3 Mounting the Enclosure

Firstly, remove the required knockouts for the installation wiring. There are sufficient knockouts on the top of the enclosure for all installation wiring. In addition, there are knockouts at the top of the back wall, if required, for rear entry cabling.

The enclosure is provided with four fixing points.

The diagram opposite shows the positions of the four holes. Use all four positions to ensure the panel is held securely to the wall.

Drill the required holes in the supporting wall using a drill bit diameter 7.0 mm and plug with a suitable 40mm long expansion plug. Affix the panel to the wall with M5 screws (length 40mm) or No.10 screws (length 1½”).

Ensure that there is sufficient space to allow the cover to be removed / replaced when the panel is mounted. In addition, there should be sufficient space below the panel to allow access to the RS232 connected, if fitted.

Finally, use a brush to remove any dust or swarf from inside the enclosure.

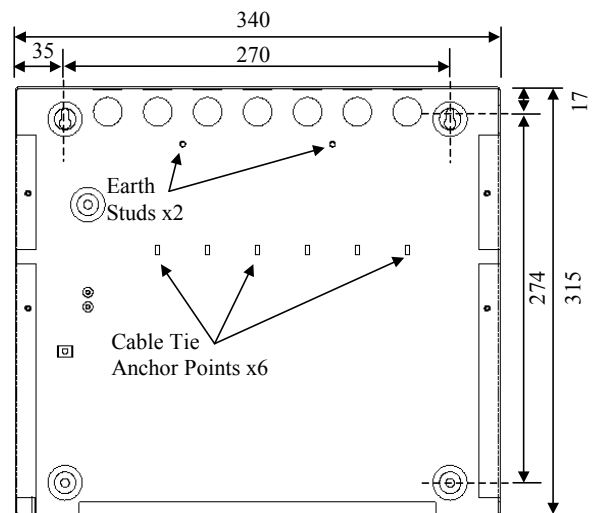

Enclosure Size and Fixing Point Dimensions

2.2.4 Remounting the Chassis

Carefully replace the chassis and fix into place using the two screws.

Reconnect the chassis earth cable to the spade terminal in the rear of the enclosure and then reconnect the supply lead from the transformer to the Base Card.

2.2.5 Recommended Cable Routing Arrangement

It is recommended that the routing arrangement shown in the diagram opposite be employed.

Segregate the low voltage wiring (Loop Circuit, Sounder Circuits and AUX Supply) from the AC Mains Wiring.

Segregate any wiring connected to the relay contacts.

Eyelets are provided in the rear of the backbox to enable the cables to be securely fastened using tie-wraps.

Refer to Appendix 2 – Recommended Cables for further information on cable types to be used.

Refer to specific sections on how to install AC Mains input and loop, sounder, relay and AUX outputs circuits.

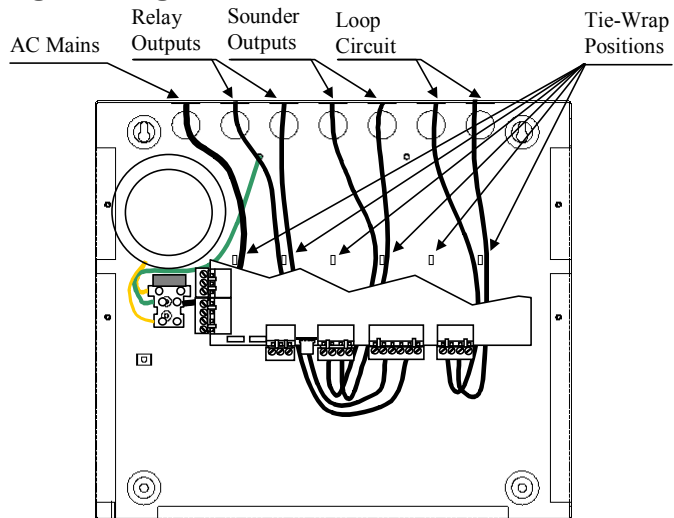

Internal arrangement showing recommended routing of cables.

2.3 Installing the Mx-4200 & 4400 Enclosures



The panel can weigh in excess of 20kg when the batteries are installed. Use appropriate fixing hardware to secure the panel to the wall. Observe recommended lifting practices to guard against spinal injury.

2.3.1 Opening the Enclosure Cover

The Mx4200 & Mx-4400 are provided with a key-lock assembly for securing the hinged door to the backbox. Insert and turn the key to open the enclosure.

2.3.2 Removing the Chassis

It is recommended that the chassis be removed before fitting the panel to the wall. To remove the chassis:

Refer to the diagram opposite.

Disconnect the earth cable connecting the chassis to the spade terminal on the rear enclosure.

Remove the bottom two screws holding the chassis to the back box. Keep these items in a safe place for later re-use.

Loosen the top two screws holding the chassis to the backbox via the keyhole slots. The chassis assembly can now be removed.

Carefully remove the chassis from the rear enclosure and place in a safe place to prevent accidental damage.

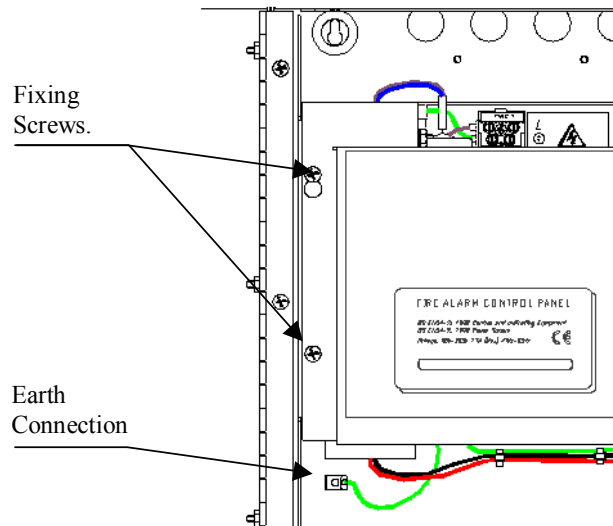

Do not lift the chassis by holding onto any of the printed circuit cards. Hold the chassis by the metal plate only.

2.3.3 Mounting the Enclosure

Firstly, remove the required knockouts for the installation wiring. There are sufficient knockouts on the top of the enclosure for all installation wiring. In addition, there are knockouts at the top of the back wall, if required, for rear entry cabling.

The diagram opposite shows the positions of the four holes. Use all four positions to ensure the panel is held securely to the wall.

Drill the required holes in the supporting wall using a drill bit diameter 7.0 mm and plug with a suitable 40mm long expansion plug. Affix the panel to the wall with M5 screws (length 40mm) or No.10 screws (length 1½").

Ensure that there is sufficient space to allow the door to be opened when the panel is mounted. In addition, there should be sufficient space below the panel to allow access to the RS232 connected, if fitted.

Finally, use a brush to remove any dust or swarf from inside the enclosure.

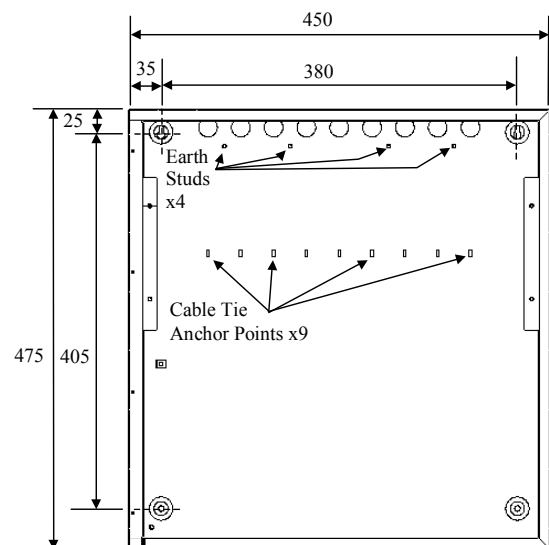

Enclosure Size and Fixing Point Dimensions

Document Reference	680-014	Rev	06	Author	PS	RFM4100	Page	11 of 53
--------------------	---------	-----	----	--------	----	---------	------	----------

2.3.4 Remounting the Chassis

Carefully replace the chassis and locate onto the upper two screws. Replace the bottom two screws and tighten all four screws to hold the chassis securely to the backbox.



Reconnect the chassis earth cable to the spade terminal in the rear of the enclosure.

2.3.5 Recommended Cable Routing Arrangement

It is recommended that the routing arrangement shown in the diagram opposite be employed.

Segregate the low voltage wiring (Loop Circuit, Sounder Circuits, RS485 and AUX Supply) from the AC Mains Wiring.

Segregate any wiring connected to the relay contacts.

Eyelets are provided in the rear of the backbox to enable the cables to be securely fastened using tie-wraps.

Sounders and AUX wiring should be routed behind the chassis assembly and tie-wrapped to the backbox.

Cable screens / shields should be connected to the backbox using the threaded studs provided near the knockout holes.

Refer to Appendix 2 – Recommended Cables for further information on cable types to be used.

Refer to specific sections on how to install AC Mains input and loop, sounder, relay and AUX outputs circuits.

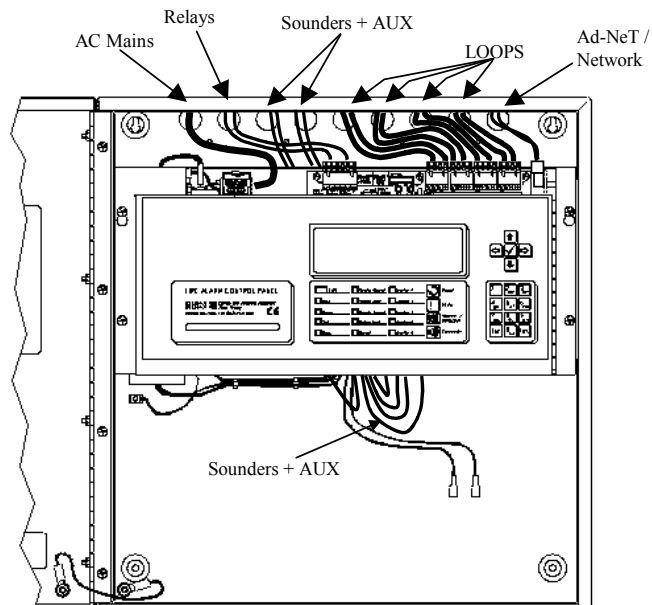

Internal arrangement showing recommended routing of cables.

2.3.6 Installing Additional Loop Circuits in the Mx4200 & Mx-4400

To extend the number of detector loops or to replace an existing loop driver card follow the procedure described below.

An example of the loop driver is shown opposite. This is provided with a plastic grip handle on the top edge to ease removal of the card from the Base Card.



Isolate ALL sources of power before installing or removing printed circuit boards.



Observe anti-static precautions at all times when handling printed circuit boards.

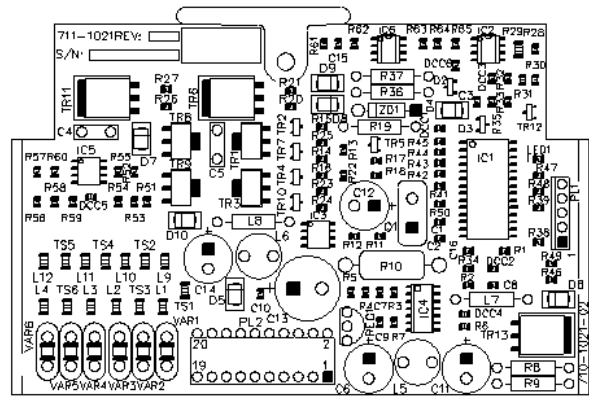

Loop Driver – Component Side View

Open the enclosure and then open the display plate (it is hinged on the right hand side and there is a magnetic catch strip on the left-hand side) to gain access to the Base Card.

A section of the Base Card identifying the locations for each loop driver is shown in the picture opposite

To install a loop driver, gently guide the loop driver printed circuit card into the guide slots of the machined end blocks and then push into place onto the connector on the Base Card.

Ensure that the pins of the connectors are correctly aligned. The loop driver should be inserted with the component side of the board placed on the left-hand side.

The Base Card can accept up to four loop driver cards – it does not matter which positions are used. Ensure that the detector loop wiring is made to the terminal block positions appropriate to the loop driver cards actually installed.

Close the chassis display plate and then close up the enclosure.

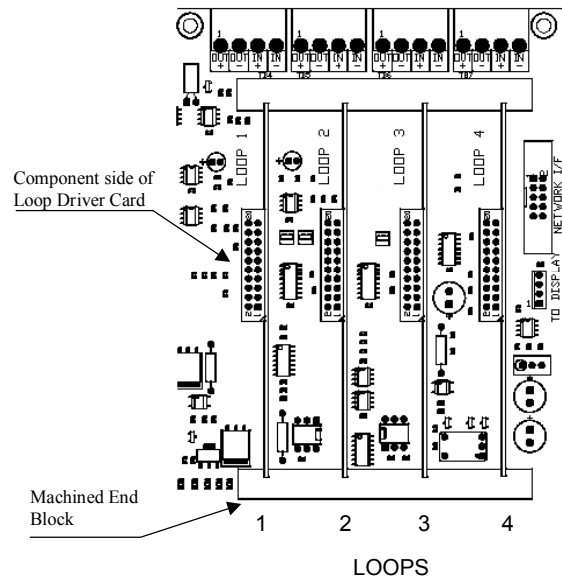

NB: The Mx-4200 only has positions 1 & 2 available.

2.3.7 Removing a Loop Driver Card

To remove a loop driver, remove all power and follow the procedure above but:

Take a firm hold of the lever located on top of the loop driver card. Gradually and carefully pull the loop driver vertically away from the base card and guide it out of the slots in the machined end blocks.

2.4 Wiring Installation

2.4.1 AC Mains Wiring

Route the high voltage mains AC wiring into the enclosure at the upper left corner only. Keep the AC wiring away from the circuit boards and all other wiring.

The panel must be connected to the supply earth through the power cable.

The mains input connector is shown in the diagram opposite. Note the positions of the earth, neutral and live terminal connections. These are clearly marked on the label next to the connector. The connector block contains an integral fuse holder.

The fuses are rated as follows:

T 1.0A H 250V (for Mx-4100)

T 3.15A H 250V (for Mx-4200 and MX4400)

Replace with correct rating and specification only.

Connect the Control Panel to the mains supply via a readily accessible; disconnect device (Isolation Switch) and suitable earth fault protection incorporated in the building installation wiring. The Mains cable should be 0.75mm² cable rated at 250V and fused via a 5A anti-surge fuse.

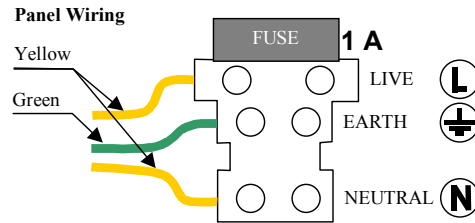

AC Mains terminations – Mx-4100.

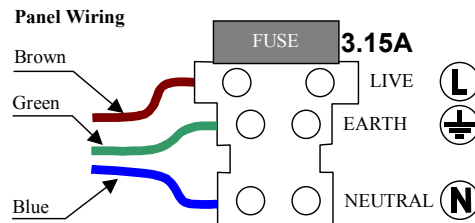

AC Mains terminations – Mx-4200 & Mx4400

2.4.1.1 Cable Gland



The cable gland and any cord clamp bushings used in routing the Mains cable through the 20mm knockout must have a minimum flame-retardant rating of 94HB.

Suggested glands and bushings are: -

Type	Manufacturer
Gland IP65 – Brass M20, EExd / Eexe	Lappcable
Gland IP68 – Nylon 66 M20 Black, UL94V2	Multicomp
Bushing – Nylon 66 M20 Black, UL94V2	Multicomp

2.4.2 Battery Installation

The panel requires two 12V batteries for standby operation.

The battery leads are connected onto the base card via a two-part plug and socket, as shown in the diagram opposite.

Refer to the Specifications for minimum and maximum battery sizes allowed.

Base Card Terminations

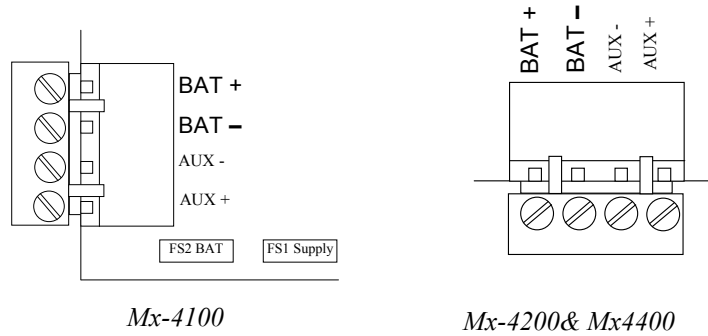

Place the batteries in the bottom of the enclosure and connect the 'Red' lead to the positive (+) terminal of battery #1 and the 'Black' lead to the negative (-) terminal of battery #2. Connect the negative of battery #1 to the positive of battery #2 using the supplied link cable.

Ensure that the battery terminals do not short out against any part of the enclosure, circuit board or chassis plate.

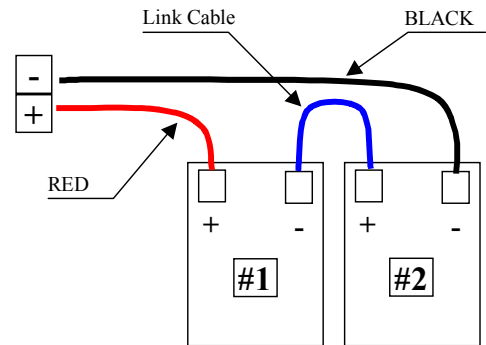

Do not make the final battery connections until the installation wiring is completed and the system is to be powered up.

Always connect the AC Mains input before connecting the battery.

New batteries require 'top-charging' before installation. Refer to Section 5.2.1.1 for a list of recommended batteries.

2.4.2.1 Mx-4100

The diagram opposite shows the recommended location and orientation for the 7AH batteries within the panel.

For battery sizes greater than 7AH, the batteries must be installed in a separate enclosure suitable for fire protection use with wiring connected to the panel through rigid conduit.

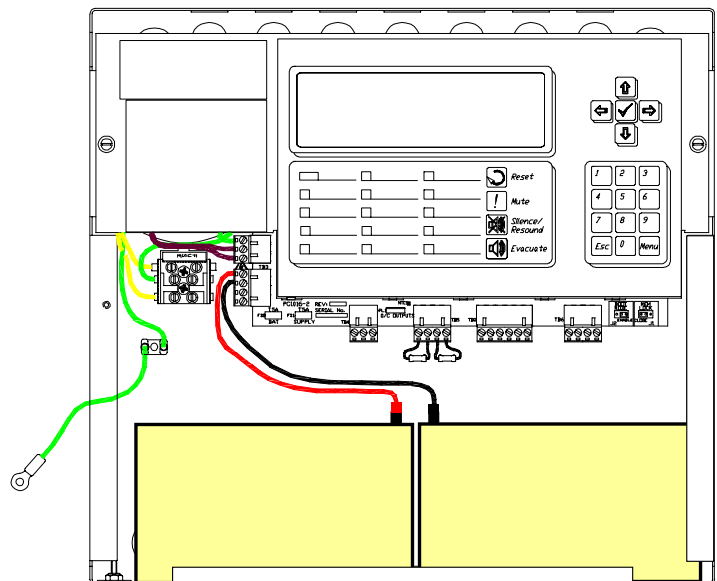

2.4.2.2 Mx-4200 & Mx-4400

The diagrams opposite show the recommended location and orientation for the 12AH and 17AH batteries within the panel.

For battery sizes greater than 17AH, the batteries must be installed in a separate enclosure suitable for fire protection use with wiring connected to the panel through rigid conduit.

For battery sizes greater than 12AH, it will be necessary to remove the spade terminals fixed to the battery leads and replace these with connection fixings suitable for the installed batteries.

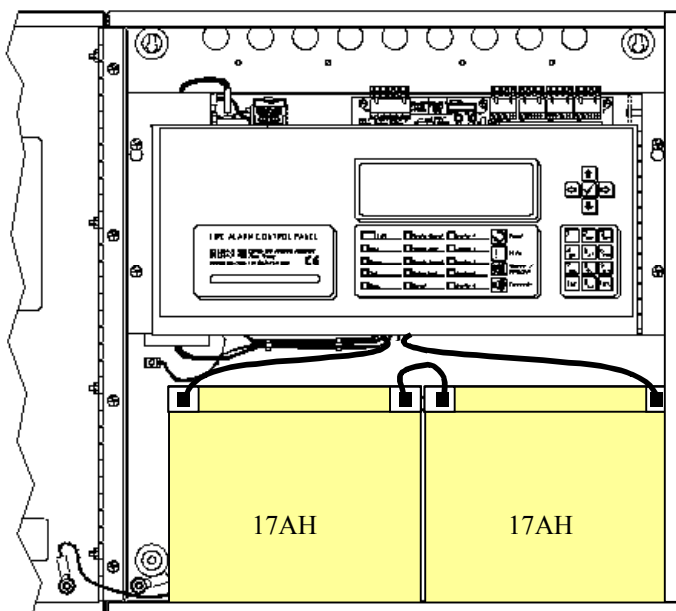
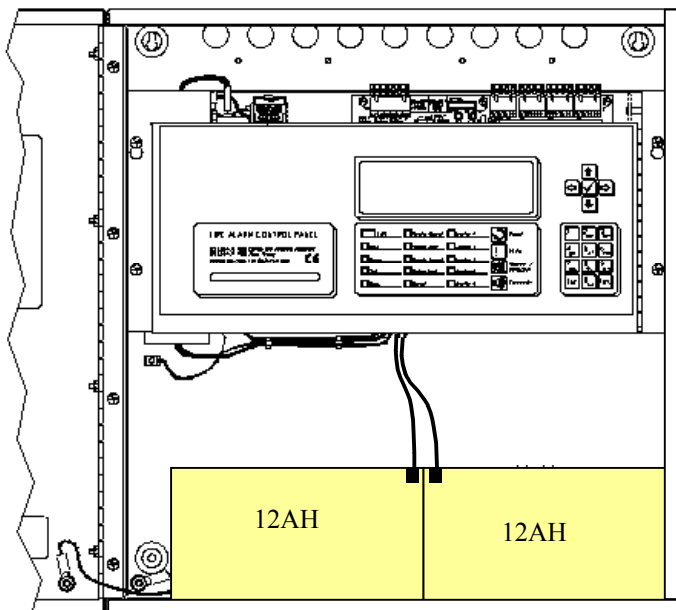

2.4.3 Detector Loop Installation



Section 12.5.2

Maximum of 32 Sensors / Call Points between Isolators.

The Detection Loop Circuit should be installed as a continuous loop with isolator modules such that a short circuit condition does not remove more than 32 input devices.

Form the loop starting at the Loop Out + and – terminals on the base card.

Route the wires around the loop connecting all devices in accordance with the manufacturers' data sheet supplied with each unit.

Ensure that the devices are correctly installed with regard to their positive and negative terminal polarity (especially Loop Isolator Modules).

Connect the return wires to the Loop IN + and – terminals on the base card.

The diagram opposite shows the typical arrangement of the loop connections on the base cards.

Refer to Section 2.3.6 for details on installing additional loop drivers on the multi-loop panels.

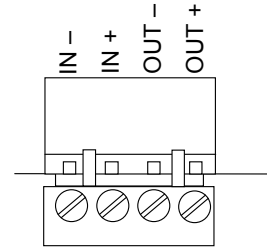

Base Card Terminations (Typical).



When screened cable is used, it is vital to connect the screen / drain wire to the chassis / earth at the cable gland input / earth stud in the panel. Always ensure that all segments of the cable loop have continuity of the screen and take care to ensure that the screen is not exposed to any other earth point (e.g. metalwork, cable trays, junction boxes, etc.).

The Loop Driver Circuit on the Base card is equipped with in-built isolators to take care of short circuit conditions on the wiring between the panel and the first device on the loop. It is not necessary to fit loop isolators at the panel outputs.

The diagram opposite shows a typical loop arrangement.

Maximum recommended cable loop length is 1500 to 2000 Metres. Refer to Appendix 2 – Recommended Cables for further information on cable types to be used.

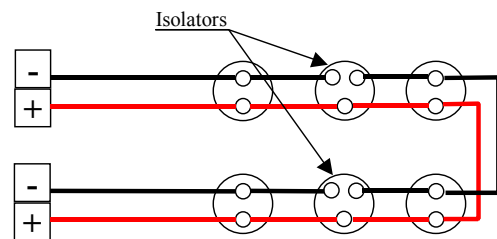

Typical Loop Arrangement.



Take care that the voltage drop at full load is within the detector rating – refer to the detector manufacturers' data sheet for minimum values.

To maintain signal line wiring supervision, break the wiring run at each loop device.

2.4.4 Sounder Circuits

The *Mx-4100* & *Mx4200* are equipped with two supervised sounder circuits. These are denoted as Circuits A and B.

The *Mx-4400* is equipped with four supervised sounder circuits. These are denoted as Circuits A, B, C and D.

Each Sounder output is rated at a maximum of 1 Ampere.

The terminal connections on the base card are shown in the diagram opposite.

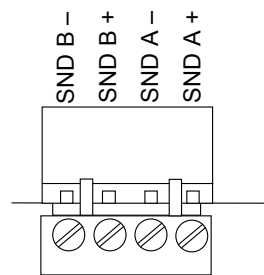

Base Card Connections – Typical.

The sounder outputs are monitored (supervised) for open and short circuit conditions using reverse polarity signals. Sounder must be equipped with an in-built blocking diode that prevents the sounder from taking power when the output is in the supervising condition.

An End-of-Line Resistor (EOLR) of value $10,000\Omega$, $\frac{1}{2}$ Watt must be fitted to the last sounder / bell.

Refer to Appendix 2 – Recommended Cables for further information on cable types to be used.

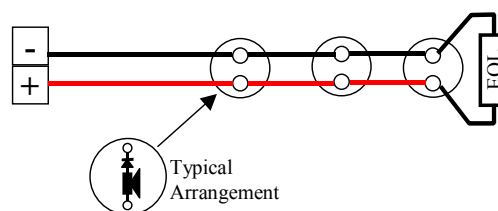

Typical Sounder Arrangement.



When screened cable is used, it is vital to connect the screen to the chassis / earth at the cable gland input / earth stud in the panel. Always ensure that all segments of the cable loop have continuity of the screen and take care to ensure that the screen is not exposed to any other earth point (e.g. metalwork, cable trays, junction boxes, etc.).

2.4.5 Relay Circuits



Section 8.8

Fault Output.

Relay 1 is arranged for failsafe operation as standard.

The panels are equipped with two relay outputs. These are normally programmed to activate on Fault and Fire Alarm conditions respectively.

Each output is unsupervised with volt-free changeover contacts rated at 30V AC/DC, 1 Ampere.

Optional relay cards are available if additional relays are required.

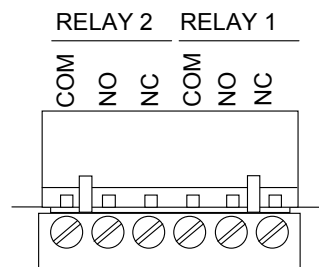

Base card arrangement – typical.

2.4.6 Open Collector Outputs

The *Mx-4100*, *Mx-4200* & *Mx-4400* are equipped with two open collector type outputs that can sink up to 10mA each from the AUX Power Output.

These are fully programmable and can be used to control external relays.

The connections of the base card are shown in the diagram opposite.

No external back-emf diodes are required.

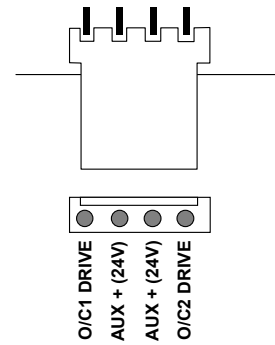

Base Card Connections - *Typical*.

The *Mx-4200* & *Mx-4400* are equipped with a further six digital programmable outputs via a 10-pin connector – see opposite.

24VDC and the Open Collector outputs are also available on this connector

An optional 8-way relay card is available to connect to this connector.

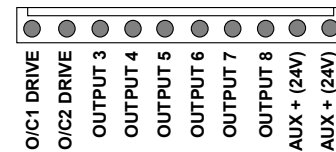

Base Card Connections – *Mx4200 & Mx-4400*

2.4.7 Auxiliary Supply Output

All panels are equipped with an auxiliary 24V DC, 300mA power supply output for powering external equipment such as the MX series remote terminals.

Base Card Connections.

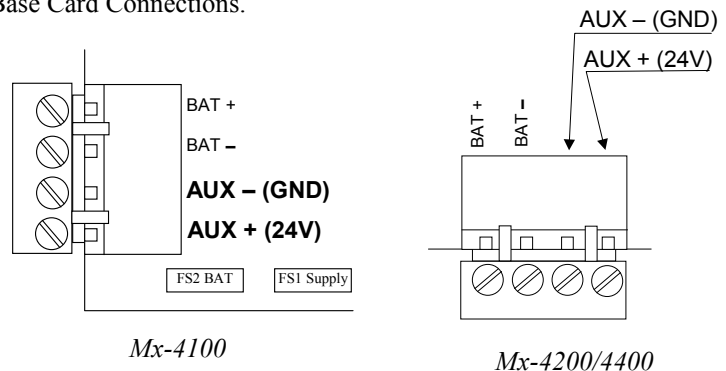

2.4.8 RS232 Interface

The *Mx-4100* is equipped with a non-isolated RS232 I/F Circuit at the bottom left-hand side of the base card.

The *Mx4200* & *Mx-4400* are equipped with an isolated RS232 I/F Circuit at the bottom of the base card.

The terminal block connections are shown opposite.

TX = Transmit Data from the panel, RX = Receive Data into the panel, GND = Ground Reference.

The RS232 I/F can be used with the **RS232 I/F Cable Kit**. This kit consists of the cable and a bulkhead mounting connector thereby enabling external connection without opening the door.

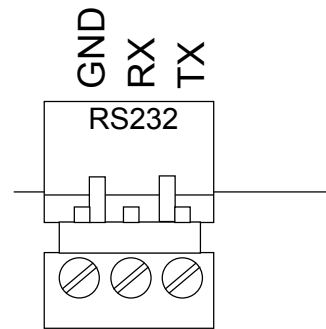

Base Card Connections - *typical*.

The internal **RS232 I/F Cable Kit** option provides connections, via a standard 9-way d-type connector, from the outside of the enclosure.

To install the cable:

1. Remove the cover plate in the bottom face of the back box.
2. Secure the D-Type Connector in the mounting hole using the fixing hardware supplied.
3. Plug the end of the cable into the socket header on the base card.

(Refer to the RS232 Interface Section above for details of the terminal block signals).

The D-Type connector can be used with:

A **PC Cable Kit** to connect the panel directly to a PC.

A **Modem and Cable Kit** for remote PC connection.

A **Printer Adapter and Cable Kits** for connection to a printer.

Contact your supplier for the relevant part numbers and order information for option kits.

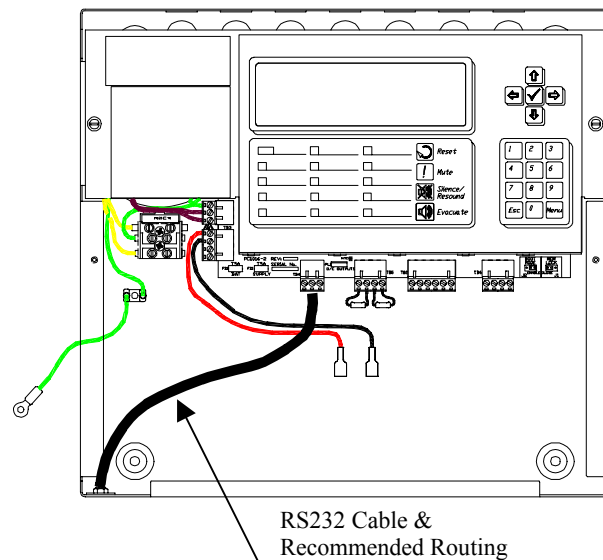

Typical Internal Arrangement – *Mx-4100 shown*

3 Programming

3.1 Introduction

3.1.1 Access Levels

The panel operation is protected from inadvertent and erroneous misuse by means of three access levels. These levels are as follows:

- Level 1 Untrained user
- Level 2 Authorised User
- Level 3 Commissioning, Service and Maintenance

This document covers the Level 3 functions.

For details on the operation and use of the panel at Levels 1 & 2, refer to User Manual 680-015.

A level 3 password is required to enter the commissioning menus. For details of Passwords, refer to Section 3.3.10.



Level-3 Passwords.

If this number is lost, it is not possible to enter commission mode functions.

Refer to 6.1 for further formation.

3.1.2 Memory Lock

The configuration memory is protected against inadvertent change by means of a memory lock.

Before making any configuration data changes, move the jumper strap to the OPEN position.

After all changes have been made, move the jumper strap back to the CLOSE position to protect the memory against inadvertent change.

Refer to the diagram opposite for information on the jumper settings.

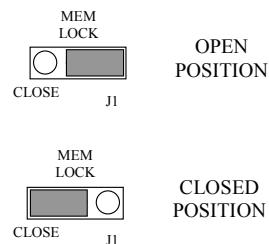

Typical View – Mx-4100

3.1.3 Navigating through menus

The display will revert to status mode after 60s. Press the 'Menu' button to restore the display.

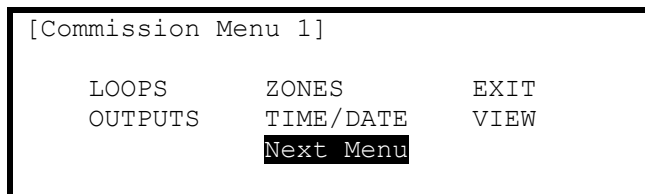

When a menu is displayed, use the **←↑↓→** buttons to highlight the required menu option and then press the **✓** button to select it.

Press the 'Esc' button from within a menu option to return to the previous menu.

The display can be forced back into status mode by pressing the 'Esc' button when at the top level commissioning menu (or by waiting 60s).

3.1.4 Changing Text Descriptions

Various parameters can have a text description defined. These include loop devices, zones, etc. The zone and device text descriptions will be shown on the display in the Fire Alarm, Fault and Warning Conditions, etc. to provide a quick and clear indication of the source of the problem.

To change the text description, first highlight the text description within the appropriate programming option and then press the ✓ button. The display then changes to show the text entry dialogue screen. For example:

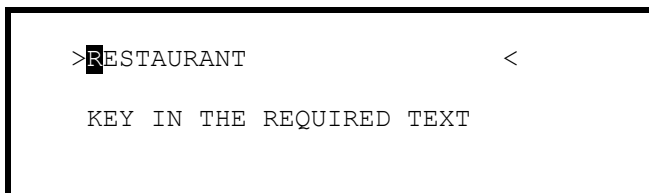

The method of entering the characters is similar to the method employed on mobile telephones. The number buttons provide both their appropriate number and several letters of the alphabet. An example of the keypad is shown opposite.

For example, Button 2 allows entry of the number 2 and letters A, B and C.

When a button is pressed, the number is first shown on the display at the current cursor position. If the button is pressed again within ½ second, the first character replaces the number. A further press displays the second available character and so on. After pressing the button to obtain the required character, wait for 1-second and the character will be entered and the cursor will move to the next character in the text description.

Pressing another button will immediately enter the previous character and move the cursor on to the next character.

Use the ←→ buttons to move backwards or forwards along the line.

When the text description is as required, press the ✓ button to confirm the change.

If the text has been entered incorrectly, press the 'Esc' button to cancel all changes and return to the previous display.

The following table shows the numbers, characters and symbols assigned to each button on the keypad.

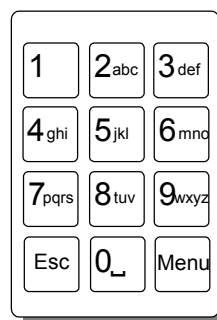

Button	1 st Press	2 nd Press	3 rd Press	4 th Press	5 th Press
1	1				
2	A	B	C	2	
3	D	E	F	3	
4	G	H	I	4	
5	J	K	L	5	
6	M	N	O	6	
7	P	Q	R	S	7
8	T	U	V	8	
9	W	X	Y	Z	9
0	Blank	0			

Alternatively, press the ↑↓ buttons to scroll through a list of characters. When the required character is shown, press the → button to move on to the next character. The list of characters available and the order of presentation is as follows:

Blank !"#%&'()*+,-./ 0123456789 ;:<=>?@ ABCDEFGHIJKLMNOPQRSTUVWXYZ [] ^ _

3.1.5 Numeric data entry

Numbers are entered by moving to the required field, then typing in the required number, followed by the ✓ button.

If the number is entered incorrectly, press the ‘Esc’ button to restore the previous number.

3.2 Recommended Programming Procedure

- Step 1 – SET-UP, Define General Set-up Information (Phone Numbers, etc.).
- Step 2 – PASSWORDS, Define Level 2 and Level 3 Passwords as required.
- Step 3 – AUTO-LEARN, Let the panel learn the devices on the loop(s).
- Step 4 – VIEW DEVICES, Enter Zone Numbers, Location text and Change Group Assignments if required.
- Step 5 – OUTPUTS, Program Output Groups as required.
- Step 6 – ZONES, Enter Zone Texts as required.

3.3 Level 3 Menu Functions

The following table gives a list of the Level 3 Menu Functions, the sub-functions available within each main function and a brief description for each function.

Main Menu Option	Sub Menus	Comments	
3	LOOPS	View/Edit	View, test and configure the loop devices
		Auto Learn	Learn the Devices Present on the Loop.
		Calibrate	Calibrates devices on the loop
6	ZONES	--	Configure the Zones.
	EXIT	--	Cancel Level 3 Access and return to Level 2 Menu Options.
5	OUTPUTS	--	Configure the Operating Characteristics of the Output Circuits.
	TIME/DATE	--	Change the Date and Time Settings.
4	VIEW	Fires	View Zones and Inputs that are reporting a fire alarm condition.
		Faults	View Zones and Inputs that are reporting a fault condition.
		Alarms	View Zones and Inputs that are reporting an alarm condition during test.
		Disabled	View Zones, Inputs and Outputs that are disabled.
		Inputs	View the current state of Zones and Inputs.
		Outputs	View the current operational condition of all output circuits.
		Log	View the Event Log.
		Panel	View the operational state, voltage & current loading of the panel I/O.
	Network	View Network Diagnostics	
2	PASSWORDS	--	Configure the Level 2 and Level 3 passwords.
	PANEL	--	Change the default zone assignments and output groups for all panel I/O.
	PC-LINK	--	Enable the PC Link for transfer of configuration data to and from the panel.
1	SETUP	--	Configure General Operating Parameters.

3.3.1 Loops

For Multi-loop panels only – On selecting the LOOPS option, the display will prompt for the loop to be viewed / programmed. E.g. for the Mx4400: -

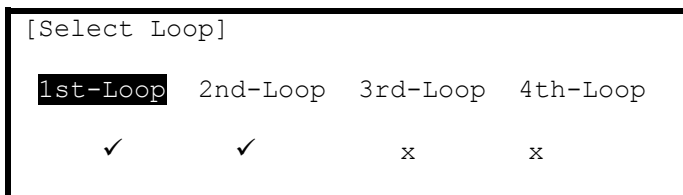

The list of loops available will be adjusted automatically to show only those loops that have a loop driver card installed. In the above example, loop drivers are installed in positions 1 and 2.

Press the $\uparrow\downarrow\leftarrow\rightarrow$ buttons to scroll through the list of loops available and then press the \checkmark button to select the loop required.

The display will then show a list of programming options as follows: (Note: On selecting the LOOPS option on the Mx4100, this display will be shown directly).

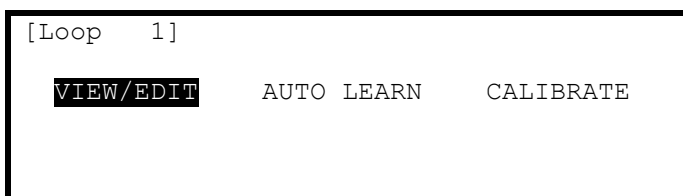

3.3.2 Loops - View/Edit

The VIEW/EDIT option shows a list of the devices connected to the loop learnt by the panel. For example:

Address	State	Type	Value
001.0	Normal	CALL POINT	16
002.0	Normal	MULTI.SENSOR	28
003.0	Normal	ION SMOKE	23
004.0	Normal	HEAT	21

The first device on the loop is shown at the top of the list and is highlighted. Press the $\uparrow\downarrow$ buttons to scroll through the list of devices.

Press the $\leftarrow\rightarrow$ buttons to view additional information. The display highlights a particular parameter. To change the value of this parameter (if not view only), press the \checkmark button and appropriate options will be shown on the display.

3.3.2.1 State

This parameter shows the current operational status of the device. For example, this can show Normal, Fire Alarm, Device Missing, etc.

This parameter cannot be changed.

3.3.2.2 Type

This parameter shows the type of device learnt by the panel. For example, this can show Call Point, Multi-Sensor, ION Smoke, Heat, etc.

This parameter cannot be changed.

3.3.2.3 Value

This parameter shows the analogue value returned by the device. The number displayed will vary according to the type of device fitted. A 'H' (High) and 'L' (Low) is shown for logic inputs. This parameter cannot be changed.

3.3.2.4 Zone

This parameter shows to which Zone the device has been assigned. Use the **number** keys to change the zone assigned to the device.

3.3.2.5 Device Text

This parameter shows the 26-character location text assigned to this device.

For guidance on how to change the text, refer to Section 3.1.4.

3.3.2.6 Action

This parameter shows the action that will be performed when this device indicates an active (alarm) condition. For example:

[Loop	1	Devices]	<More>
Address	Action	Sensitivity	O/P
001.0	FIRE SIGNAL	DEFAULT	
002.0	FIRE SIGNAL	DEFAULT	
003.0	FIRE SIGNAL	DEFAULT	
004.0	FIRE SIGNAL	DEFAULT	

Press the **✓** button to change the action assigned to this input device. A pop-up window is then shown on the display from which an action can be selected.

[Select New Action]
FIRE SIGNAL
PRE-ALARM
FAULT SIGNAL

Press the **↑↓** buttons to scroll through the list of Actions and then press the **✓** button to confirm the change. The display reverts to the device list showing the new action assigned to this device. Alternatively, press the **'Esc'** button to cancel the changes and return to the device list display. The following Actions are available (Additional actions are available on a PC)

Action	Description
Fire Signal	A Fire Alarm Condition will be generated whenever the input is active.
Pre-Alarm	A Pre-Alarm Condition will be generated whenever the input is active.
Fault Signal	A Fault Condition will be generated whenever the input is active.
Security	A Security Alert Condition will be generated whenever the input is active.
Record	A Record Entry will be stored in the Log whenever the input is active. This will be hidden from the panel status display.
Create Alarm 1	An "Alarm 1" condition will be generated whenever this input is active.
Create Alarm 2	An "Alarm 2" condition will be generated whenever this input is active.
Create Alarm 3	An "Alarm 3" condition will be generated whenever this input is active.
Key Lock	Inhibits front panel controls (Disable, Mute, Reset etc.)
-	No Action is assigned to the input.
Control Signal	Allows control of Outputs without displaying "Fault" or "Fire" or sounding buzzer

Document Reference	680-014	Rev	06	Author	PS	RFM4100	Page	25 of 53
--------------------	---------	-----	----	--------	----	---------	------	----------

Fire Alarm Conditions are latched.

By default, all other conditions are non-latching.

The action for smoke and certain other detectors is always fire and cannot be changed.

3.3.2.7 Sensitivity

This parameter shows if the device sensitivity is set to it's "DEFAULT" or "CUSTOM" settings. For example:

```
[Loop 1 Devices] <More>
Address Sensitivity
001.0 DEFAULT
002.0 DEFAULT
003.0 CUSTOM
004.0 DEFAULT
```

Press the ✓ button to change the sensitivity assigned to an input device. When selected a new screen displays the sensitivity settings assigned. For example, with an Apollo Discovery

```
SENSITIVITY ADJUST MODE (ION SMOKE )
[ Alarm = 55 ]
[ Mode = 3 ][ Pre-Alarm= 45 ]
[ Delay = 5s][ Min.Value= 8 ]
[SAM/SSM]
```

Press the ←↑↓→ buttons to highlight the required menu option and then press the ✓ button to select it. Use the **number** buttons to enter the required value. Alternatively, press the 'Esc' button to cancel the changes.

The alarm thresholds and delay times can be unique for every device if required.



Always ensure that the values chosen are suitable for the particular installation and that reliable fire coverage is maintained at all times.

3.3.2.7.1 Mode- Apollo:

This is applicable to Discovery devices only.

The panel fully supports the sensitivity modes within the Discovery devices. Refer to the Apollo technical documentation for a detailed description and recommended use of these bands.

Different sensitivity modes can be chosen for both day and night periods. This field can be set in the range 1 – 5.

3.3.2.7.2 Mode- Hochiki:

This is applicable to Multi-sensor devices only:

- Mode 0: (Default) Combined optical & heat detectors
- Mode 1: Optical mode only
- Mode 2: Heat mode only

3.3.2.7.3 Delay

The value in this field defines the delay from detecting an alarm to entering the alarm condition. The delay time can be changed in 1-second increments.

3.3.2.7.4 Alarm- Apollo

The Alarm Level is the level of the analogue value returned by the detector at which the panel will enter a Fire Alarm Condition. The default value is 55. Setting the value higher will mean that more smoke / higher temperature is required before the panel will enter the alarm condition. Setting the value lower will mean that less smoke / temperature is required before the panel will enter the fire alarm condition.

The alarm level cannot be set outside the safe operating limits defined for the particular device.

Apollo Discovery devices always use a value of 55.

3.3.2.7.5 Alarm- Hochiki

The Alarm Level of the Analogue value returned by the detector at which the panel will enter a fire condition is set to Hochiki Alarm thresholds (expressed as a % value) This is normally 3% for Multi-sensor & Optical devices. Refer to Hochiki Data Sheets for further information.

3.3.2.7.6 Pre-Alarm

The Pre-Alarm Level is the level of the analogue value returned by the detector at which the panel will enter a pre-alarm condition.

3.3.2.7.7 Minimum Value

If the detector analogue output falls below the minimum value programmed, the panel will enter a fault warning condition. This parameter is normally left at a value of 8 for Apollo detectors and 0 for Hochiki.

3.3.2.7.8 Special Sensitivity Mode SSM/Clock

In addition to the “SENSITIVITY ADJUST MODE”, a device can also run in a “SPECIAL SENSITIVITY MODE” (SSM) under time-clock control.

The *Mx4100* supports 3 independent, 7-day time clocks.

The *Mx4200* supports 10 independent, 7-day time clocks.

The *Mx4400* supports 10 independent, 7-day time clocks.

With the SAM/SSM Option highlighted, press the button to view the Special Sensitivity Mode settings. For example:

```
SPECIAL SENSITIVITY MODE (MULTI.SENSOR)
[SSM/Clock = 2 ][ Alarm = 55 ]
[ Mode = 5 ][ Pre-Alarm= 40 ]
[ Delay = 5s][ Min.Value= 8 ]
[ SAM/SSM ]
```

In the above example the panel is using special sensitivity mode 2 (and time clock number 2). Enter “0” in the SSM/Clock field to cancel Special Sensitivity Mode.

A number must be entered in the SSM/Clock field to select the appropriate SSM number and time clock. To view the time clock settings, highlight the SSM/Clock field, and press the ✓ button.

For example:

[Time Clock 2]						
DAY	ON	->	OFF	ON	->	OFF
MON	00:00	00:00	19:00	00:00		
TUE	00:00	06:30	00:00	00:00		
WED	00:00	00:00	00:00	00:00		
THU	00:00	00:00	00:00	00:00		

The panel supports two independent times for each day of the week during which the SSM mode will be switched on (i.e. during which the Special Sensitivity Mode settings are active)

In the above example the SSM will be active between 19:00 on Monday and 06:30 on Tuesday.

Press the ←↑↓→ buttons to select the appropriate time field and use the **number** buttons to enter the required times. Press the 'Esc' button to return to the previous menu display.

Every type of device (the device type is shown in the top, right hand corner) supports unique SSM settings for each SSM/Clock number. In the previous example the Special Sensitivity Mode settings have been defined for a Multi-Sensor that is using SSM/Clock number 2. If other Multi-sensors on the same panel also require the same settings, then you only need to set them to SSM/Clock 2. If instead another Multi-Sensor requires a different setting, use a different SSM/Clock number.

3.3.2.8 O/P Group

The Output Group assigned to the Sounder or Relay Devices determines the manner in which the outputs will operate when a fire alarm or other programmed condition occurs.

For example:

[Loop 1 Devices]	<More>
Address	O/P Group
020.0	199
021.0	199
022.0	199
023.0	199

Use the **number** buttons to change the value of the O/P Group setting.

By default, all Loop Output devices are assigned to Output Group 199.

For detailed information and guidance on the programming and use of Output Groups, refer to Section 3.3.6.

3.3.2.9 Additional Info

This parameter shows additional information, if available, for this device. For example, the following display shows the Apollo detector series types:

[Loop 1 Devices]	<More>
Address	Additional Info
001.0	Disco
002.0	XP95
003.0	Disco
004.0	Disco

For further information on this option, refer to Appendix 5 – Apollo Information and Appendix 6 – Hochiki Esp Information.

3.3.2.10 Detector Testing

Individual detectors can be tested to check the chamber response and illuminate the detector LED.

While the address field is highlighted, press the **↑↓** buttons to scroll through the list of devices to the desired detector (or key in the address, and then press the **✓** button).

A menu will appear to confirm that you want “Test This Detector”.

Press the **✓** button to confirm or press the **‘Esc’** button to cancel.

Once selected, commands are sent to the detector to turn on the detector LED and put the chamber into test. The “Test” LED lights up and the panel display returns to the list of devices.

After a few seconds the analogue signal will be seen to rise. If the detector is then left in the test condition, the Detector State will change to a “Fire Test” status.

The test is cancelled as soon as the display is scrolled up or down or when the ‘View Devices’ option is exited.

3.3.3 Loops - Auto Learn

3.3.3.1 Normal Procedure / Initial learn

The panel can automatically learn the presence or absence of devices at all addresses connected to the loop. When the Auto Learn option is selected, the panel starts searching each address on the loop to locate and find all of the devices connected. A display is shown to indicate the progress of this procedure.

For example:

```
[Auto Learn Loop 1] HOCHIKI
Address 15 Devices found = 3
```

When all addresses have been searched, the panel displays a summary screen showing the quantity of devices found for each type of device.

For example:

```
[Auto Learn Loop 1] HOCHIKI
Address 127 Devices found = 4
OPT ION MUL TMP MCP SCC I/O ZMU OTHERS
0 1 1 1 1 0 0 0 0
```

This summary provides a quick check to ensure that the panel has found all of the devices that should be connected to the loop.

Press the **‘Esc’** button to return to the main Loops Menu.

3.3.3.2 Procedure if the Panel finds Devices Missing

When the panel cannot communicate with a device previously programmed into the panel, the Auto Learn process is suspended and the display shows a pop-up window with options. For example:

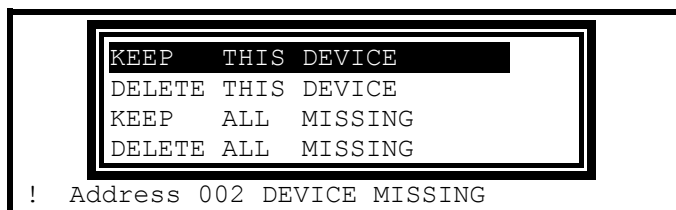

If the missing device is kept (or all missing devices are kept), the panel remembers the programming for these devices. The panel will report a fault condition until such time as the missing devices are reconnected.

If the missing device is deleted (or all missing devices are deleted), the panel clears all previous programming for these devices. This includes any sensitivity threshold changes, text assignments, zone assignment, action, etc.

Press the $\uparrow\downarrow$ buttons to highlight the required menu option and then press the \checkmark button to confirm. The pop-up window will disappear and the panel will continue with the auto learn process.

If a single device is deleted and another missing device is subsequently registered, the display will once again show the pop-up window to keep or delete this device.

3.3.3.3 Procedure if the Panel finds Devices Added

When the panel finds a device not previously learnt and programmed in the panel, the Auto Learn process is suspended and the display shows a pop-up window with options. For example:

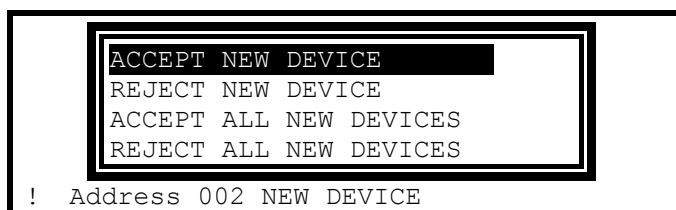

If the new device is accepted (or all new devices are accepted), the panel will configure the memory to register these devices. All data will be configured to initial settings for sensitivity threshold changes, text assignments, zone assignment, action, etc. for these devices.

If the new device is rejected (or all new devices are rejected), the panel clears all programming for these devices and will not attempt to communicate with the devices at these addresses.

Press the $\uparrow\downarrow$ buttons to highlight the required menu option and then press the \checkmark button to confirm. The pop-up window will disappear and the panel will continue with the auto learn process.

If a single device is accepted / rejected and another new device is subsequently registered, the display will once again show the pop-up window to accept or reject this device.

3.3.3.4 Procedure if the Panel finds Devices Changed

When the panel finds a new type of device installed at an address previously learnt and programmed in the panel, the Auto Learn process is suspended and the display shows a pop-up window with options. For example:

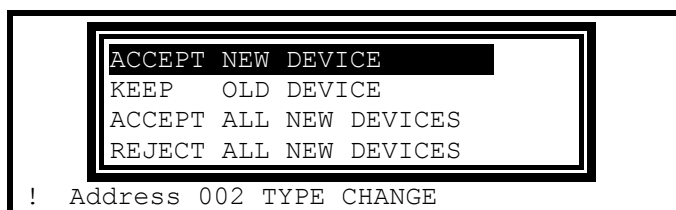

This situation could arise for example if a heat detector has been installed in place of an optical smoke detector.

If the new device type is accepted (or all new device types are accepted), the panel will configure the memory to register these devices. All data will be configured to initial settings for sensitivity threshold changes, text assignments, zone assignment, action, etc. for these devices.

If the new device type is rejected (or all new device types are rejected), the panel remembers the programming for the original devices. The panel will report a fault condition until such time as the correct device types are reconnected.

Press the **↑↓** buttons to highlight the required menu option and then press the **✓** button to confirm. The pop-up window will disappear and the panel will continue with the auto learn process.

If a single device is accepted / rejected and another new device type is subsequently registered, the display will once again show the pop-up window to accept or reject this device.

3.3.4 Zones

The Commission Zones option lists all the zones in use by the panel and allows the zone text description to be changed.

[Commission Zones]	
Zone	Location
0001	BASEMENT WEST
0002	RECEPTION
0015	EAST WING
0018	TOWER BLOCK

To change the location text assigned to the Zone, press the **✓** button when the Zone Location Text is highlighted. Refer to Section 3.1.4 for guidance on how to change text descriptions.

To select a different zone, either use the scroll up/down keys, or just type in the number of the required zone, followed by the **✓** button. Note that only zones in use are displayed.

3.3.5 Exit

To exit the Commission Mode functions and return the panel to normal operation (ie level 2), select the “Exit” option. The display will prompt for confirmation of the password. For example:

[Commission Menu 1]	
Please Enter Your Password	
Next Menu	

The display will then present the Level 2 Menu Functions.

If the password is incorrect (this will be indicated) or if the password is not entered within 5-seconds, the display will revert to the Commission Level Menu and level-2 will not be entered.

After commissioning, the panel must always be returned to level 2 (or level 1) to give normal fire coverage.

3.3.6 Outputs

The “Cause and Effect” programming is a schedule of actions that will turn on one or more outputs dependant on a set of input events.

The Outputs Option provides the means to create simple or complex “cause and effect” programming within the panel. Delays can be introduced to allow a phased evacuation of a building (Note this is different to an “Investigation Delay” which is detailed in section 3.3.7) .

This section describes the settings and options in detail for each parameter. Refer to Appendix 4 – Cause and Effect Programming Example for a description of how to program a typical requirement.

More complex “Cause and Effect” programming may be undertaken using the PC Configuration tool.

When the OUTPUTS Option is selected, the display shows the cause and effect programming for Output Group 1. For example:

[Output Group 1]			[3.9% Mem used]		
ZONE	GROUP	CAUSE	STYLE=Delay->	MODE	
1	1	ANY FIRE	00	-	On
2	1	ANY FIRE	00	-	On
3	1	ANY FIRE	00	-	On
4	1	ANY FIRE	00	-	On

To simplify the cause & effect programming, one or more outputs that will respond in the same way when the same set of input events occurs can be grouped together. This association of outputs is called an Output Group.

The panel can support up to 200 of these Output Groups.

To select a different Output Group, highlight any group number and then enter the number of the output group required using the **number** buttons. The display always shows the Output Group is shown in the top left corner.

Press the **↑↓** buttons to scroll through the list of zones.

Press the **←→** buttons to select the fields for a particular zone.

Press the **✓** button to select a particular field option to change its setting.

3.3.6.1 Default Output Settings

On initial installation, or after clearing the configuration memory, all outputs are assigned to specific Output Groups and will turn on immediately a single fire alarm occurs in any zone (any fault condition for the fault relay). The default assignments are as follows:

Output Device	Output Group	Cause and Effect
On-board Sounder A	1	Any fire in any zone – no delay
On-board Sounder B	2	Any fire in any zone – no delay
On-board Sounder C *	3	Any fire in any zone – no delay
On-board Sounder D*	4	Any fire in any zone – no delay
On-board Relay 1	200	Any fault in any zone – no delay
On-board Relay 2	199	Any fire in any zone – no delay
On-board Open Collectors	199	Any fire in any zone – no delay
All Loop Output Devices	199	Any fire in any zone – no delay

* Mx4400 only

3.3.6.2 Cause

Each Output Group can be programmed to respond in a unique way to events from each individual zone. An input event may be a fire alarm condition or it may be a fault, disablement or other condition. A combination of criteria may also be applied to each zone.

The Cause field determines what type of input event (or a combination of input events) will generate an output response for the selected input zone.

To inspect or change the Cause, press the **→** button to highlight the cause option. For example:

[Output Group 1]		[3.9% Mem used]			
ZONE	CAUSE	STYLE=Delay->MODE	Wait		
1	ANY FIRE	00	-	On	
2	ANY FIRE+	00	-	On	
3	ANY FIRE	00	-	On	
4	ANY FIRE	00	-	On	

Press the **✓** button to change the setting and a pop-up window will appear showing the options available. For example:

[FIRE]	[D/K FIRE]	[ALARM]	[PRE-ALARM]
✓	-	-	-
[FAULT]	[I/P DISABLE]	[TEST]	[CONTROL]
-	-	-	-

Press the **←↑↓→** buttons to highlight the required menu option and then press the **✓** to change its setting. An input action type is enabled when a '✓' is shown beneath the option. It is permitted to select multiple input types in which case a combination of input events will result in an output action. If there is a combination of input events, the CAUSE display above shows this extended programming by adding a '+' to the text. For example, Zone 2 above shows that the basic event is ANY FIRE + other criteria.

Press the 'Esc' button to return to the previous display.

The definition for each cause is as follows:

Fire	Any single fire.
Double Knock (D/K)	Coincidence of 2 or more fire detectors or a single manual call point in the same zone.
Alarm	Activation of an input device programmed with an 'Alarm' action.
Pre-Alarm	A device in a pre-alarm condition.
Fault	Any device entering a fault condition.
Input Disabled	Whenever an input device is disabled.
Output Disabled	Whenever an output device / circuit is disabled.

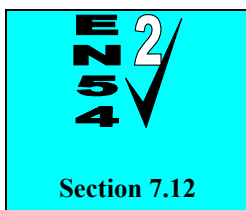

Coincidence Detection.

The operation of the Coincidence Detection (Double Knock) feature is on a per zone basis.

3.3.6.3 Style

The way in which an output turns on in response to a particular input event can be programmed. For example, an output may turn on immediately, it may turn on after a delay or it may pulse for a set time and then turn on. This method of operation is called a Style. A style may have up to three different methods of operation. For example,

Delay → Mode, Wait → Mode, Wait → Mode.

Style 00 is fixed to turn on immediately an input event occurs.

Style 01 defaults to pulse immediately an input event occurs.

Styles 02 to 20 are programmable (02 to 10 on Mx4100).

Press the → button to step on to the style field. Change the setting using number entry to select the required output style. If the style is already programmed elsewhere, the relevant style parameters are automatically entered into the appropriate fields.

3.3.6.3.1 Delay

The delay field is the time from qualification of the input event to something happening at the output. The delay time can be set in intervals of 1 second up to a maximum of 250 seconds.

Press the → button to step on to the delay field and change the setting using number entry.

3.3.6.3.2 Mode

The mode field defines the method of operation of the output when it is first activated. This can be ON or PULSE.

Press the → button to step on to the delay field and change the setting using the ✓ button.

3.3.6.3.3 Wait

The wait field is the time from first activation of the output to the next operational condition (mode) of the output. For example, the output could initially be delayed for 20 seconds and turn on in a pulsing mode. After a wait of a further 30 seconds it can be programmed to turn on differently such as ON. The wait time can be set in intervals of 1 second up to a maximum of 250 seconds.

Press the → button to step on to the wait field and change the setting using number entry.

3.3.6.4 Copying Output Settings to Multiple Zones

To save time in the entry of similar Output Group Settings for each zone, it is possible to copy information programmed for a particular zone to subsequent zones.

Press the ← button to highlight the required zone number and then press the ✓ button. The display shows a pop-up window prompting for the number of the zone to which to copy the information.

Use the number entry to select the required zone number. The Output Group programming for all of the zones from the currently selected zone to the zone number entered will be programmed with the same information as the currently selected zone.

3.3.7 Investigation Delays

In addition to the “Cause and Effect” programming described above, the panels also support an “Investigation Delay Mode” which allows time for a building supervisor to investigate fire signals before turning outputs on. This mode can only be configured from the PC software.

There are two parts to this delay. The first stage is set relatively short. If the building supervisor does not acknowledge the fire signal within the first stage, the delayed outputs will turn on. The second stage gives a longer period to investigate the fire signal. This delay can be cancelled at any time by pressing the EVACUATE button, or any nominated input devices (by default, all call points cancel this mode).

Each input and output device can be individually programmed to use the investigation delay from the PC configuration software, together with the times appropriate to each stage of the delay. The user manual gives details of how the building occupier can turn the investigation delay feature on or off.



Section 7.11

Delays to Outputs.

It must be possible to override the operation of any delays at Level 1. Refer to Section 3.3.7.1 for information on overriding delays.

For compliance, the maximum total delay permitted is 10 minutes.

3.3.7.1 Overriding Delays at Level 1

A facility to override any programmed delays and immediately activate the sounder circuits should be provided at Level 1. It is possible to override the delay using the panel controls (see the user manual for details). This can also be achieved from an input device that is programmed to turn on all outputs immediately..

3.3.8 Time and Date

This function allows the time and date in the panel to be changed. On entry to the function, the display shows the current time and date with confirmation of the day of the week on the bottom line. For example:

```
[SET TIME/DATE]
TIME = 15:28
DATE = 15/04/02    MON 15 APR 2002
```

To change the settings, use the **↑↓** buttons to highlight the required option. Directly enter the new time or date using the **number** buttons. As soon as a **number** button is pressed, the display will clear the current setting and show the new value as it is entered. For example:

```
[SET TIME/DATE]
TIME = 1:--
DATE = 15/04/02    MON 15 APR 2002
```

3.3.9 View Options

The View Menu Options are identical to those available during Level-2 operation.

For further information on the View Options and the information that is presented, refer to the User Manual (Document No. 680-015).

3.3.10 Passwords

The panel provides up to 10 User Level-2 passwords and 2 Level-3 passwords. All of the passwords can be changed.

On entry to the function, the display shows a list of the passwords. For example:

Password	Access level	User ID
15633	2	01
9988	2	02
13344	2	03
10000	2	04
10000	2	05

To change a password, use the $\uparrow\downarrow$ buttons to highlight the required password and then enter the new password using the **number** buttons. When the password is correct, press the \checkmark button to confirm.



Level-3 Passwords.

Care should be taken when changing the Level-3 password. If this new number is lost, it is not possible to enter commission mode functions.

Refer to 6.1 for further information.



The factory default level 3 password is 7654

3.3.11 Panel

The Panel Menu Option shows a list of the internal panel circuits and provides a means to change their default configuration settings.

Only use this menu if changes are to be made to the default settings for the panel's internal circuits. Use the VIEW-PANEL Menu Option to view the state and operating condition of each circuit.

The display shows for example:

Address	State	Type	Value	More>
>001.0	Normal	VOLTAGE	5.6V	
001.1	Normal	VOLTAGE	5.6V	
002.0	Normal	CURRENT	0mA	
002.1	Normal	CURRENT	0mA	

Use the $\uparrow\downarrow$ buttons to scroll through the circuits. Use the $\leftarrow\rightarrow$ buttons to view additional information. The zone and Output Group Assignments can be modified if required.

For further information on the View – Panel Options and the information that is presented, refer to the User Manual (Document No. 680-015).

3.3.12 PC Config



The PC Link Option enables the connection of the PC Configuration Tool for retrieving configuration data from the panel and programming configuration data from a file on the PC.

For further information, refer to the Manual supplied with the PC Configuration Tool.

3.3.13 Setup

The Setup Options Menu enables the configuration of panel generic operating parameters. When the option is selected, the display shows a list of the available parameters. For example:

```
[Setup]
THIS NETWORK NODE : 0
NEXT NETWORK NODE : 0
PANEL ZONE       : 100
SERVICE NUMBER  : 01234 567890
```

Use the   buttons to scroll through the list of options. The following will then be shown:

```
[Setup]
SERVICE DUE DATE : 1 JAN 2011 10:00
TRACE LOGGING MODE : STANDARD More>
DETECTOR BLINKING : NONE
COMPANY LCD LOGO  : ✓
```

3.3.13.1 Network

This Network node is set to 0 for a standard non-networked panel. For panels in a networked application please refer to the Network document, reference: 680-027.

3.3.13.2 Panel Zone

By default all the panel inputs are assigned to the Panel Zone. Alternatively the PC configuration program allows individual inputs to have different zones if required.

3.3.13.3 Service Number

The Service Number is the telephone number that is shown on the status display whenever a fault condition occurs. To change the number, press the  button when the option is highlighted. The number is entered using the text entry facility, refer to Section 3.1.4 for guidance on how to enter text.

3.3.13.4 Service Due Date

The next service (over)due date can be entered into the panel memory. When this date is reached, the panel will enter a fault condition to alert the site operator that a service visit is overdue. To change the due date, press the ✓ button when the option is highlighted. The display prompts for entry of the next service date. For example:

```
[NEXT SERVICE DUE]

      TIME = 12:00
      DATE = 24/04/02
```

Use the ↑↓ buttons to select between the time and date. Use the number buttons to enter the required time or date.

As soon as a new service date is entered, the panel will cancel any Service Due Fault condition.

3.3.13.5 Trace Logging Mode

The Trace Logging Option determines what type of information and to what level is stored in the Event Log.

There are three options:

STANDARD = the normal operating mode logging fire alarm, fault and warning conditions as they occur.

STANDARD + = an extended version of the standard operating mode where the removal of fault and warning conditions are also logged.

DIAGNOSTIC = a full diagnostic trace of all conditions with greater depth to aid diagnosis of fault conditions.

To change the option, press the ✓ button.

To erase the event log, press the → button to view the additional command option as follows:

```
[Setup]

TRACE LOGGING MODE : Wipe Event Log
DETECTOR BLINKING  :
COMPANY LCD LOGO   :
PROGRAM ID         :
```

Press the ✓ button and the display will show that the event log is being erased by display the message “WORKING...”. After the event log is erased, the display reverts to the Set-up Options screen.

3.3.13.6 Detector Blinking

The Detector Blinking option determines whether the LED indicators on the devices will blink whenever the panel polls the device. To change the operation, press the ✓ button. The display presents a list of options. For example:

```
[Setup]

SERV ALL
SERV NONE 0:00
TRAC
DETECTOR BLINKING : ALL
```

Use the ↑↓ buttons to scroll through the list of options and press the ✓ button to confirm the selection.

The device LED indicators will not blink if NONE is chosen or will blink if ALL is chosen. Note that only certain devices, such as Apollo Discovery, support this feature.

If a device, such as a Discovery device, is changed it may be necessary to select and reconfirm the blinking command so that the new device will blink its LED.

The INDIVIDUAL option should be chosen when it is required that only certain devices should blink their LED. The devices that shall blink their LED can only be programmed using the PC Configuration Tool.

3.3.13.7 Company LCD Logo

This parameter determines whether the Company Logo is shown on the display during normal operation. To change the setting, press the ✓ button. The status changes from ✓ to X and vice versa.

3.3.13.8 Program ID

The display shows the part number and version of the software installed in the panel. Press the → button to see the program checksum (8 digits)

3.3.13.9 Config Data

The Config Data option shows the loop protocol selected and the checksum for the configuration data. A note of this number can be taken and then checked on the next service visit to see if any changes have been made to the configuration data.

In addition, there is an option to erase the Config Data.

To view the Config Data Checksum, press the → button. The display then shows:

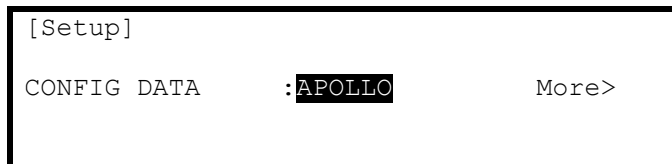

To change the protocol, press the ✓ button. A pop up window is shown with the following options

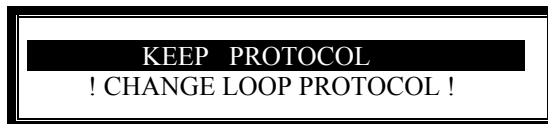

Use the ↑↓ buttons to select the required options and press the ✓ button to confirm the selection.

Selecting "CHANGE LOOP PROTOCOL" will toggle to the alternative loop protocol available (ie: Apollo/Hochiki)



Changing between protocols will automatically erase all loop devices from the configuration memory. Perform an "Auto-Learn" or use the PC Config Tool to re-define the devices connected to the loop.

4 EN54 Optional Features

In addition to the mandatory requirements of EN54 Part 2, the MX Control and Indicating Equipment (C.I.E) support the following optional features :-



Section 8.3

Fault Signals from Points.

The C.I.E is able to receive and process fault signals from points. These are indicated on a per zone basis. Refer to the User Manual for further information.



Section 7.8

Outputs to Fire Alarm Devices.

The C.I.E has provision for connection to Fire Alarm Devices. It is possible to Silence and Resound the alarms at Level 2. Refer to the User Manual for further information.



Section 7.11

Delays to Outputs.

The C.I.E has provision for Output and Investigation Delays. Refer to Section 3.3.6 for further information



Section 7.12

Coincidence Detection.

The C.I.E has provision for Coincidence Detection. Refer to Section 3.3.6 for further information.



Section 9.5

Disablement of Points.

The C.I.E has provision for enabling and disabling signals from points. Refer to the User Manual for further information.



Section 10

Test Condition.

The C.I.E has provision for testing the installation on a per zone basis. Refer to the User Manual for further information.

5 Service and Maintenance

5.1 Maintenance Schedule

It is recommended that the following maintenance schedule as per EN54-14 be adopted.

5.1.1 Daily Actions

The site operator / user should perform the following checks and actions:

- a) The panel indicates normal operation. If any faults exist, these should be recorded in the logbook.
- b) Any recorded faults have received attention and have been signed off.

5.1.2 Monthly Actions

The site operator / user should perform the following checks and actions:

- a) Any stand-by generators should be started and fuel levels checked.
- b) Operate at least one call point or detector (from different zones each month) and check that the panel enters a fire alarm condition and that the appropriate / programmed alarm or warning devices are sounded / operated. Where permissible, this should include any links to the fire brigade or remote centre.
- c) Check that all outstanding faults have been recorded and have received attention.

5.1.3 Quarterly Actions

The service / maintenance contractor should perform the following checks and actions:

- a) Check that all entries in the logbook have been addressed, check the event log in the panel and take the necessary remedial actions.
- b) Visually inspect the panel for any moisture ingress or other deterioration, check all battery connections and test / check the alarm, fault and other functions of the panel operation.
- c) Ascertain if any building or structural alterations have been carried out that would affect the siting of call points or detectors. If so, perform a visual inspection.
- d) Record in the logbook any defects or remedial actions that must be undertaken and arrange for these to be carried out as soon as possible.

5.1.4 Annual Actions

The service / maintenance contractor should perform the following checks and actions:

- a) Perform the checks as recommended above in the daily, monthly and quarterly schedules.
- b) Perform a complete "Walk Test" of the system to check that each call point and detector is operating to its manufacturers' specification.
- c) Visually inspect all cable fittings. Check that the equipment is undamaged and that the conditions of installation have not changed such that they fall outside of the equipment specifications.
- d) Inspect and test all batteries and replace as required – refer to Section 5.2 for recommended replacement schedule.
- e) Record in the logbook any defects or remedial actions that must be undertaken and arrange for these to be carried out as soon as possible.

5.2 Replacement of Components

In general, all of the components parts used in the construction of the panel have been selected for long life and reliability.

However, certain components may require to be changed on a regular service basis. The details of these are as follows:

5.2.1 Batteries



Respect the Environment.

Batteries must be disposed of responsibly and in accordance with any local regulations.

5.2.1.1 Standby Batteries

Expected Life	-	3-5 years at an ambient temperature of 20°C	
Replacement Schedule	-	As above. However, note that the expected battery life is shortened by increase in ambient temperature. The life reduces by 50% for every 10°C rise above ambient. Refer to battery manufacturer for further information.	
Manufacturer / Part Numbers	-	YUASA	POWERSONIC
		4AH NP4-12	5AH PS-1250-F1
		7AH NP7-12	7AH PS-1270
		12AH NP12-12	12AH PS-12100-F1
		17AH NP18-12	18AH PS-12180-NB
		24AH NP24-12B	26AH PS-12260-NB

Batteries connected in parallel 48AH (2 x NP24-12B)



For optimum performance and charge retention, Yuasa recommend that batteries are 'top-charged' prior to installation.

For batteries up to 6 months old from date of manufacture, charge at 2.4V per cell (i.e. 14.4V per battery) for 20 hours prior to installing the batteries.

It is not recommended to use batteries that are older than 6 months from the date of manufacture on a new installation.



It is quite normal for lead-acid batteries to vent hydrogen when being charged.

The panel is adequately ventilated to dissipate this hydrogen. DO NOT seal the enclosure or install in a sealed enclosure or cavity.

5.2.1.2 Lithium Battery



WARNING – A lithium battery is used for data retention and for the real time clock.

Replace only with the same type or authorised equivalent. This battery is not rechargeable.

Expected Shelf Life	-	> 10 years
Replacement Schedule	-	10 years for panels in continuous service 10 years for spares (i.e. when the panel / board is not powered) Replace if the battery voltage falls below 2.6 volts.
Manufacturer / Part Number	-	CR2032

5.2.2 Liquid Crystal Display

Expected Life	-	> 10 years
Replacement Schedule	-	When the display becomes difficult to read. The display contrast will gradually fade with time.
Manufacturer / Part Number	-	Replace the complete display / keyboard assembly. Spare part number MXS 004.

6 Appendices

6.1 Appendix 1 – Forgotten Level 3 Password

Should the Level-3 password be forgotten, contact Customer Support to obtain a temporary permit number to regain access to the panel programming functions.

Customer Support will require a decryption key displayed by the panel. To obtain this number, attempt to gain access to the Level-3 Programming Functions entering “1” when prompted for the password. As soon as the “Password Invalid” message is shown, press the “0” button and the display will show a decryption key. Make a note of the first part of this number.

For example:

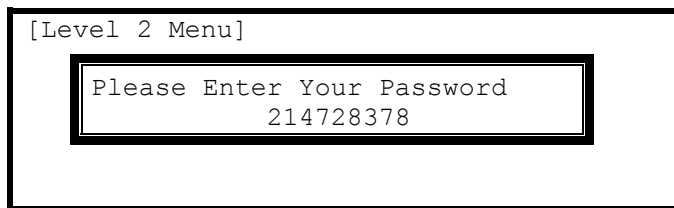

Customer Support will provide a temporary permit number that you can enter when prompted for the Level-3 password. As soon as access has been regained to the Level-3 Programming Functions, select the Passwords Menu Option and check / change the Level-3 password. (Refer to Section 3.3.10 for further information).

6.2 Appendix 2 – Recommended Cables

Detector Loop & Sounder Circuits

Manufacturer	Cable Type	
AEI	Firetec Multicore Ref. F1C1	(1.0mm ²)
AEI	Firetec Multicore Ref. F1C1.5	(1.5mm ²)
AEI	Firetec Multicore Ref. F1C2.5	(2.5mm ²)
AEI	Firetec Armoured Ref. F1C1	(1.0mm ²)
AEI	Firetec Armoured Ref. F1C1.5	(1.5mm ²)
AEI	Firetec Armoured Ref. F1C2.5	(2.5mm ²)
AEI	Mineral Insulated Copper Cable	(1.0mm ²)
AEI	Mineral Insulated Copper Cable	(1.5mm ²)
AEI	Mineral Insulated Copper Cable	(2.5mm ²)
BICC	Mineral Insulated Twin Twisted CCM2T1RG	(1.0mm ²)
BICC	Mineral Insulated Twin Twisted CCM2T1.5RG	(1.5mm ²)
CALFLEX	Calflam CWZ	(2.5mm ²)
DRAKA	Firetuf (OHLS) FTZ	(1.0mm ²)
DRAKA	Firetuf (OHLS) FTZ	(2.5mm ²)
HUBER & SUHNER	Radox FRBS/M1x2x1.5	(1.5mm ²)
HUBER & SUHNER	Radox FRBS/M1x2x2.5	(2.5mm ²)
PIRELLI	FP200 Gold	(1.0mm ²)
PIRELLI	FP200 Gold	(1.5mm ²)
PIRELLI	FP200 Gold	(2.5mm ²)

6.3 Appendix 3 – Battery Standby Calculation Chart

Use the following charts and associated notes to calculate the size of the batteries required to ensure operation of the installation in the event of AC Mains power failure.

6.3.1 Mx-4100

Equipment	Quiescent Load			Fire Alarm Load		
	I (A)	x	Total	I (A)	x	Total
<i>Mx-4100</i>	0.115	1.0	= 0.115	0.225	1.0	= 0.225
Auxiliary Supply Output		1.0	=		1.0	=
Sensor / Loop Current ¹		1.25 ²	=		1.25	=
Sounder Output A					1.0	=
Sounder Output B					1.0	=
Total	ΣQuiescent Load			ΣAlarm Load		
	x 24 hr =		AHr	x 0.5 hr =		AHr
			↖ (carry forward)	+	AHr	
	Total Load (Quiescent + Alarm) =					AHr
	x 1.2³ (Battery Derating factor) =					AHr

¹ Use the detector manufacturers' technical information to calculate the load on the loop for both the quiescent condition and fire alarm condition for all loop devices. By default, a maximum of 5 detector / call point LED indicators will be turned on in a fire alarm condition. (This number can be changed via the PC Programming Tool).

² The calculated loop loading must be multiplied by a factor of 1.25 to calculate the actual current draw from the batteries. This is to take into account voltage conversion and conversion efficiency in generating the supply for the loop.

³ The total load calculated must be multiplied by a derating factor of 1.2 to allow for changes in battery efficiency over time.

6.3.2 Mx-4400 & Mx-4200

Equipment	Quiescent Load			Fire Alarm Load		
	I (A)	x	Total	I (A)	x	Total
Mx-4400/Mx4200	0.083	1.0	= 0.083	0.178	1.0	= 0.178
Auxiliary Supply Output		1.0	=		1.0	=
Loop Driver	0.042	1.0	=	0.042	1.0	=
Sensor / Loop Current ¹						
Loop Driver	0.042	1.0	=	0.042	1.0	=
Sensor / Loop Current						
Loop Driver	0.042	1.0	=	0.042	1.0	=
Sensor / Loop Current						
Loop Driver	0.042	1.0	=	0.042	1.0	=
Sensor / Loop Current						
Sounder Output A					1.0	=
Sounder Output B					1.0	=
Sounder Output C*					1.0	=
Sounder Output D*					1.0	=
Total	ΣQuiescent Load			ΣAlarm Load		
	x 24 hr =		AHr	x 0.5 hr =		AHr
			▲	(carry forward) +		Ahr
	Total Load (Quiescent + Alarm) =					AHr
	x 1.2³ (Battery Derating factor) =					AHr

Notes: * Only used on the Mx-4400

¹ Use the detector manufacturers' technical information to calculate the load on the loop for both the quiescent condition and fire alarm condition for all loop devices. By default, a maximum of 5 detector / call point LED indicators will be turned on in a fire alarm condition. (This number can be changed via the PC Programming Tool).

² The calculated loop loading must be multiplied by a factor of 1.25 to calculate the actual current draw from the batteries. This is to take into account voltage conversion and conversion efficiency in generating the supply for the loop.

³ The total load calculated must be multiplied by a derating factor of 1.2 to allow for changes in battery efficiency over time.

6.4 Appendix 4 – Cause and Effect Programming Example

6.4.1 Introduction

By default, all sounders and output devices will turn on immediately as soon as a fire is detected anywhere in the system. For example:

Cause	Effect
Any Fire, Anywhere.	→ ALL Output Devices will Turn ON

Quite often an installation will require a more complex “Cause and Effect” solution. Consider a multiple story building where phased evacuation is required when a fire occurs on a particular floor. For example:

Cause	Effect
Any Fire on Floor 7 (From Zones 22, 23 or 24)	→ Sounders on Floor 6 will DELAY for 30 seconds, then start PULSING. After 2 minutes turn ON
	→ Sounders on Floor 7 will Turn ON
	→ Sounders on Floor 8 will DELAY for 30 seconds, then start PULSING. After 2 minutes turn ON

6.4.2 Output Groups

There may be several sounders on each floor. These can be grouped together using the Output Groups so that a single group number can easily reference all sounders on a particular floor in the panel. For example:

Sounders	Output Group
Assign All Sounders of Floor 6	→ Output Group 6
Assign All Sounders of Floor 7	→ Output Group 7
Assign All Sounders of Floor 8	→ Output Group 8

Refer to Section 3.3.2.8 for how to assign the output group to a loop output device. Refer to Section 3.3.11 for how to assign the output group to an internal panel circuit.

6.4.3 Styles

In the example, there are two ways in which the sounders should ring. These two operational characteristics can be defined as Styles in the panel. For example:

The first Style is that the sounders should turn on immediately a fire is recognised in Zone 22 or in Zone 23 or in Zone 24. The panel contains a default Style (Style 00) for this method of operation.

The second Style is that the sounders should stay silent for 30 seconds and then start pulsing. After 2 minutes of pulsing, they should then turn on. This is a little more complex but is easy to program. In the following description, a new Style (Style 2) will be defined for this purpose.

It is quite likely that Style 2 will be used extensively in the cause and effect programming for the rest of the building. For example, a fire on Floor 8 may also require the sounders on Floors 7 and 8 to operate in this manner.

6.4.4 Output Group Programming

To achieve the above cause and effect requirements, the three different Output Groups would be programmed and indicated on the panel as in the following display examples:

Output Group 6 – Sounders on Floor 6:

[Output Group 6]		[3.9% Mem used]				[STYLE 02]			
ZONE	GROUP	CAUSE	STYLE=Delay->MODE			Wait	MODE	Wait	MODE
22	6	ANY FIRE	02	30s	Pulse	120s	On		
23	6	ANY FIRE	02	30s	Pulse	120s	On		
24	6	ANY FIRE	02	30s	Pulse	120s	On		

More>

Output Group 7 – Sounders on Floor 7:

[Output Group 7]		[3.9% Mem used]				[STYLE 00]			
ZONE	GROUP	CAUSE	STYLE=Delay->MODE			Wait	MODE	Wait	MODE
22	7	ANY FIRE	00	-	On				
23	7	ANY FIRE	00	-	On				
24	7	ANY FIRE	00	-	On				

More>

Output Group 8 – Sounders on Floor 8:

[Output Group 8]		[3.9% Mem used]				[STYLE 02]			
ZONE	GROUP	CAUSE	STYLE=Delay->MODE			Wait	MODE	Wait	MODE
22	8	ANY FIRE	02	30s	Pulse	120s	On		
23	8	ANY FIRE	02	30s	Pulse	120s	On		
24	8	ANY FIRE	02	30s	Pulse	120s	On		

More>

6.5 Appendix 5 – Apollo Information

Special Discovery specific features are available from the “Additional Info” field of the Loop View/Edit display. It is then possible to view the internal Drift, perform a rapid compensation or access any of the internal Discovery EEPROM memory locations. Press the ✓ button and a pop-up window is shown presenting a list of options.

For example:

```
[Loop 1 Devices] <More>
Address Additional Info
>001.0 Disco
002.0 XP95
003.0 Disco
004.0 Disco
```

Press the ↑↓ buttons to highlight the required menu option and then press the ✓ button to confirm.

6.5.1 View Drift

The display then shows the Discovery devices that the panel is reading. For example, select the View Drift option and the display shows:

```
[Loop 1 Devices] <More>
Address Additional Info
>001.0 Disco Reading..
002.0 XP95
003.0 Disco Reading..
004.0 Disco Reading..
```

When the reading is complete, the display shows the drift within the device. For example:

```
[Loop 1 Devices] <More>
Address Additional Info
>001.0 Disco Drift = 16
002.0 XP95
003.0 Disco Drift = 16
004.0 Disco Drift = 16
```

Refer to Apollo’s literature for an explanation of the drift mechanism and for further information on the expected values.

6.5.2 Rapid Compensation

Apollo has incorporated a rapid compensation facility into the Discovery devices. If a device is changed during service it can be quickly adjusted to the present ambient conditions.

Highlight the required “Disco” family device, select RAPID COMPENSATION and then press the ✓ button to confirm. The panel will now instruct this device to perform a rapid compensation. This will take approximately 30 seconds.



**This operation must only be performed with the detector in clean air.
No other operation should be performed on this device during this rapid compensation period.**

6.5.3 View EEPROM

The panel can read any of the extended memory locations within the Discovery devices.

Highlight any “Disco” family device, select VIEW EEPROM and then press the ✓ button to confirm. The display will prompt for entry of the required extended memory address. For example:

```
[Loop 1 Devices] <More>
Address Additional Info
>001.0 Disco
002.0
003.0 EEPROM ADDRESS=#
004.0
```

Enter the required address using the number buttons and then press the ✓ button to confirm.

The panel will now read the extended memory locations for all Discovery devices on the loop. When complete, the display will present the information as follows:

```
[Loop 1 Devices] <More>
Address Additional Info
>001.0 Disco EEP[ 1] = 23
002.0 XP95
003.0 Disco EEP[ 1] = 21
004.0 Disco EEP[ 1] = 22
```

Refer to Apollo’s literature for an explanation of the extended memory locations and for further information on the expected values.

6.6 Appendix 6 – Hochiki Esp Information

At power up the panel allows a couple of minutes for Hochiki Esp detectors to stabilise. Any detectors that the panel knows to be present will then be calibrated. The panel displays can be used normally during this time, but the fire detection response will be slower until all the calibration phases are complete. If devices are inspected during this period, they may show their state as: -

- “Reset” - panel has reset the device at power up, resetting from a fire etc.
- “Calibrating” - checking ESP “Zero Point” and “Fire Points”
- “Initialising” - loading detection thresholds, sounder volumes etc.

Calibration can be manually initiated any time at access level 3, forcing all the devices on the selected loop to be calibrated. Transferring new device information from a PC to the panel will also cause the effected devices to be re-calibrated.

Periodic re-calibration can be performed at levels 1 & 2 under control of one of the 7-day timeclocks. The timeclock settings are configured from PC program.

6.6.1 Unprocessed Analogue information

For most purposes the “Value” field in the View/Edit menu gives the easiest to read and the most useful information from a detector as it is scaled and displayed in standard engineering units. It is, however, possible to see the unprocessed analogue signal (AN) by moving to the Additional Info field.

[Loop	1 Devices]	<More>
Address	Additional	Info
001.0	AN =	85
002.0	AN =	81
003.0	AN =	97
004.0	AN =	83

Press the ✓ button to cycle through and display the stored Calibration Zero-point (ZP) and the Calibration Fire-point (FP).

6.6.2 CHQ-BS Sounders

Unlike standard sounders, the CHQ-BS sounders can be programmed to give out many different tones and be individually programmed to adjust the sound output. When programmed from the panel they will default to turn on at 85dB. Use one of the many tones available from the PC instead of the standard “Pulse” option if any special ringing is required.

The panel utilises the “group” features of the CHQ-BS, so that when a command is sent to turn one device on, all other CHQ-BS devices within the same group will turn on at virtually the same time from the same command (and likewise when they are silenced).

6.7 Appendix 7 – Mx4000 Series Loop Output Drive Capability

The following information is applicable per loop. All loops can be loaded to the maximum (500mA per loop).

Provision has been made to allow for a typical loading of detectors and inputs (30mA).

6.7.1 Hochiki

Volume	Number of Loop Powered Sounder Bases
98db	29
or	
95db	42
or	
94db	47
or	
93db	58
or	
90db	72
or	
88db	104
or	
85db	127

6.7.2 Apollo

Volume	Number of Loop Powered Sounders
100db	104 Loop Powered Sounders
or	
92db	57 Sounder Bases
or	
85db	126 Sounder Bases



The number of devices shown is representative for specific loop arrangements. If there is a mixture of sounder types or sounder volumes on the installation or if the other devices on the loop take more than 30mA in quiescent or alarm, then calculate the actual current load in alarm using the current consumption figures quoted in the device data sheets and ensure that this does not exceed the maximum output for the loop.

Refer to Apollo and Hochiki LoopCalculator for further information on calculating loop loading, cable cross sectional area and loop distance.